









business specified storage

BISLEY



contents

	number of years guarantee
	anti-tilt
	100% opening drawer
	locking
	A4 - A0 sizes
	A4 suspension filing
	foolscap suspension filing
	lateral filing pockets
	box files
	small parts storage
	stationery
	cd storage
	video storage
	card files
	garment storage
	standard colour palette
	fast track colour palette
	additional colour palette

introduction	4
section 1 filing cabinets	
1.1 flush front filing cabinets	8
1.1 A4 double filers	8
1.2 aoc cabinets	10
1.2 contract filing cabinets	10
1.3 side filers	12
section 2 storage for home & office	
2.1 12 series multidrawers	16
2.1 29 series multidrawers	16
2.2 39 series multidrawers	18
2.2 A3 series multidrawers (29 & 39 series)	18
2.2 BA3 single door locking cupboard	19
2.2 optional base	19
2.3 home multidrawers	20
2.3 insert trays	20
2.4 colour options	22
2.4 pfa home filer	22
2.5 f series - flush front & classic front	24
2.5 media storage cabinets	24
section 3 storage specialisms	
3.1 A0 plan files	28
3.1 A1 plan files	28
3.2 card filing cabinets	30
3.2 card index cabinets	30
section 4 vertical storage	
4.1 two door cupboards	34
4.1 open front cupboards	34
4.2 stationery cupboards	36
4.3 side opening tambours	38
4.3 cupboard fitments	38
4.4 contract side opening tambour	40
4.4 internal fitments for side opening tambours	40
4.4 safety warning for cupboards	40
4.5 A4 eurotambours	42
4.6 lockers	44
4.7 static shelving	46
section 5 desk associated storage	
5.1 bite®	50
5.2 towers	52
5.3 note pedestals	54
5.4 wave pedestals	56
section 6 storage systems	
6.1 systemfile combination units	60
6.2 systemfile tambour cupboards	62
6.2 systemfile two door cupboards	63
6.3 systemfile - combination (individually locking)	64
6.3 systemfile - interior components	65
6.4 systemfile - internal specifications	66
6.4 systemfile - vertical capacities	67
6.5 InnerSpace	68
appendix: colour	70
general terms & conditions	71

All Bisley manufactured products are 'business specified' to customer requirements. Complementing each product technical specification, the Bisley business specification ensures that every Bisley product is backed by a well-managed, customer-focussed company, continuously reinvesting in its future.



business specification

item	description	price
product	consistently meeting the standards of performance our customers expect	inclusive
service	job done accurately and on time, delivering our promises	inclusive
relationships	suppliers, customers and employees dealt with evenly and fairly	inclusive
efficiency	resources used to the full, wasting nothing and doing only what we do best	inclusive
responsibility	to have a positive influence on the communities we affect	inclusive
innovation	consistently improving our processes to better serve our customers	inclusive



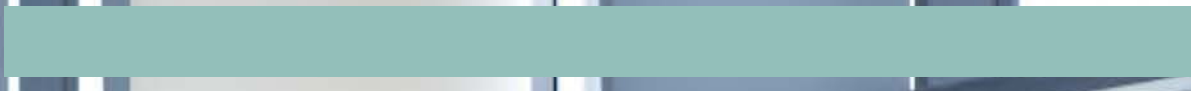
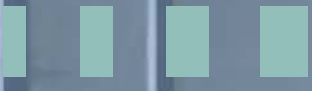

BISLEY

BISLEY

BISLEY

BISLEY

- 1.1 flush front filing cabinets
- 1.1 A4 double filers
- 1.2 aoc cabinets
- 1.2 contract filing cabinets
- 1.3 side filers



tried and tested

Practical and robust, Bisley manufactured filing cabinets are still the best solution to straight forward filing requirements.

All drawers are mounted on high-durability slides which provide ultra-smooth action and full extension for access to the whole drawer. All cabinets feature integrated drawer interlocks and are rigorously tested to BS4875 Pt7: Strength & Stability of Furniture.



BS filing & double filer cabinets



Bisley filing cabinets are built to last featuring a one-piece carcass, fully welded construction and double skin drawer fronts. Drawers are mounted on roller bearing slides with a positive closing device, providing ultra-smooth action and full extension for access to the whole drawer. The range includes five, four, three and two drawer versions for foolscap or A4 filing.

Bisley Double Filers offer a large capacity cabinet able to accommodate two rows of forward facing suspension files per drawer. Double Filers are suitable for A4 or American letter format and are available as three or four drawer models.

Easy to use PC templates allow computer printed labels.

flush front filing cabinets

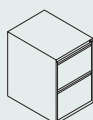

1623/3623

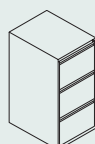

1633/3633

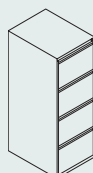

1643/3643



1653

foolscap	description	height	width	depth
1623	(BS2E) 2 drawer cabinet	711 (28")	470 (18.5")	622 (24.5")
1633	(BS3E) 3 drawer cabinet	1016 (40")	470 (18.5")	622 (24.5")
1643	(BS4E) 4 drawer cabinet	1321 (52")	470 (18.5")	622 (24.5")
1653	(BS5E) 5 drawer cabinet	1511 (59.5")	470 (18.5")	622 (24.5")
PCF744FP5	Compressor plates (black only) pack of 5			
PCF744FP4	Compressor plates (black only) pack of 4			
Suffix 0	Security bar (factory fitted)			

A4	description	height	width	depth
3623	(A4BS2E) 2 drawer cabinet	711 (28")	413 (16.2")	622 (24.5")
3633	(A4BS3E) 3 drawer cabinet	1016 (40")	413 (16.2")	622 (24.5")
3643	(A4BS4E) 4 drawer cabinet	1321 (52")	413 (16.2")	622 (24.5")
BSCPAHSP5	Compressor plates (black only) pack of 5			
Suffix 0	Security bar (factory fitted)			

Measurements in millimetres (approx. inches)

A4 double filers



DF3

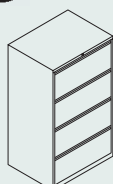

DF4

item	description	height	width	depth
DF3	3 drawer cabinet	1016 (40")	800 (31.5")	622 (24.5")
DF4	4 drawer cabinet	1321 (52")	800 (31.5")	622 (24.5")

Measurements in millimetres (approx. inches)



- 100% extension drawers (0.56m linear capacity)
- fully welded carcase without bolts or rivets for greater strength and cleaner line
- backs and sides are pierced to enable units to be bolted together
- filing cabinets can be fitted with compressor plates

1. easy print labels and holder
2. mastered lock, 200 differs
3. approved to BS EN 14073: pts 2+3 & BS EN 14074
4. two rows of A4 suspension files in double filer



1

2

3

4



AOC & CC contract filing cabinets



The Bisley 'AOC' filing cabinet represents great value for office storage. Backed by Bisley's strength in manufacturing, features such as 100% drawer extension, smooth resistance-free slides and anti-tilt operation deliver quality and reliability.

Strong, attractive and safe, the 'CC' filing cabinets are the ideal choice for any office. Heavily supported by office products wholesalers, the CC filing cabinet is the cornerstone of the Bisley 'fast track' range of affordable 'storage essentials' available in fast track colours on quick delivery.

aoc cabinets

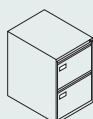

AOC2

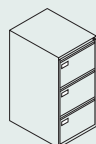

AOC3

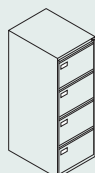

AOC4

item	description	height	width	depth
AOC2	2 drawer cabinet	711 (28")	470 (18.5")	622 (24.5")
AOC3	3 drawer cabinet	1016 (40")	470 (18.5")	622 (24.5")
AOC4	4 drawer cabinet	1321 (52")	470 (18.5")	622 (24.5")

Measurements in millimetres (approx. inches)

contract filing cabinets



CC2H1A



CC3H1A



CC4H1A

item	description	height	width	depth
CC2H1A	2 drawer cabinet	711 (28")	470 (18.5")	622 (24.5")
CC3H1A	3 drawer cabinet	1016 (40")	470 (18.5")	622 (24.5")
CC4H1A	4 drawer cabinet	1321 (52")	470 (18.5")	622 (24.5")

Measurements in millimetres (approx. inches)



- 100% extension drawers (0.54m linear capacity)
- fully welded carcase without bolts or rivets for greater strength
- approved to BS EN 14073: pts 2+3 & BS EN 14074

1. large label holder
2. mastered lock, 200 differs
3. hardwearing textured paint finish
4. fast track colour palette



side filers



Bisley side filers are ideal where floor space is limited. The range incorporates all the design features of standard filing cabinets but with 30% greater capacity. The drawers, each supported by heavy duty slides enable 100% extension and accommodate one row of foolscap suspension files facing sideways or two rows of A4 files facing forwards.

Easy to use PC templates allow computer printed labels.

side filers

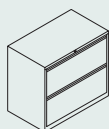

08SF2



08SF3

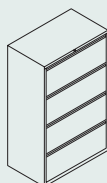

08SF4

item	description	height	width	depth
08SF2	2 drawer cabinet (complete with cross rails)	693 - 717 (27.2 - 28.2")	800 (31.5")	470 (18.5")
08SF3	3 drawer cabinet (complete with cross rails)	997 - 1021 (39.2 - 40.2")	800 (31.5")	470 (18.5")
08SF4	4 drawer cabinet (complete with cross rails)	1301 - 1325 (51.2 - 52.2")	800 (31.5")	470 (18.5")

Measurements in millimetres (approx inches)



- smooth action, heavy duty ball bearing slides with 100% extension
- fully welded carcass without bolts or rivets for greater strength and cleaner line

1. easy print labels and holder
2. mastered lock, 200 differs
3. approved to BS4875 pt 7
4. side or front facing filing

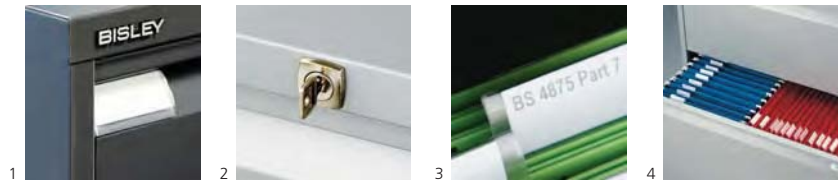



BISLEY



BISLEY

- 2.1 12 series multidrawers
- 2.1 29 series multidrawers
- 2.2 39 series multidrawers
- 2.2 A3 series multidrawers (29 & 39 series)
- 2.2 BA3 single door locking cupboard
- 2.2 optional base
- 2.3 home multidrawers
- 2.3 insert trays
- 2.4 colour options
- 2.4 pfa home filer
- 2.5 f series - flush front & classic front
- 2.5 media storage cabinets



well organised

Still the most versatile office storage solution, and perfect for individual needs, the Bisley small office range is available in a variety of cabinet and drawer heights with a selection of drop-in accessories.

Available in a broad range of colours and designed to fit on or under a desk, these compact, affordable cabinets are ideal for the home office and media storage environments.



12 & 29 series multidrawers



Bisley 12 Series make great storage units for office or home use. Available with drawer 'heights' from 25mm to 87mm and multi-compartment insert trays for small item storage, the 12 Series is ideally suited to storing all types of stationery.

The 29 Series desk top / under desk are available with a choice of 6 drawer 'heights' from 25mm to 102mm and multi-compartment insert trays for small item storage, the 29 Series is perfect for higher capacity applications. 4, 6 and 10 drawer A3 versions are also available.

12 series multidrawers

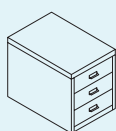

055/054

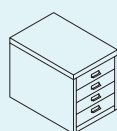

059/058

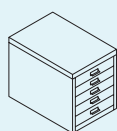

053/052

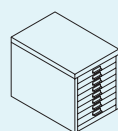

062/060

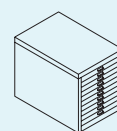

057/056



155C/154C

locking	non locking	description	drawer height	height	width	depth
055	054	12/3 multidrawer (3)*	87	325 (12.7")	279 (11")	408 (16")
059	058	12/4 multidrawer (4)*	64	325 (12.7")	279 (11")	408 (16")
053	052	12/5 multidrawer (5)*	51	325 (12.7")	279 (11")	408 (16")
062	060	12/8 multidrawer (8)*	30	325 (12.7")	279 (11")	408 (16")
057	056	12/10 multidrawer (10)*	25	325 (12.7")	279 (11")	408 (16")
155C	154C	12/3 cattle passport (1+2)*	51, 102	325 (12.7")	279 (11")	408 (16")

* Number of drawers
Measurements in millimetres (approx. inches)

29 series multidrawers



187/185



063/061



067/065



087/085

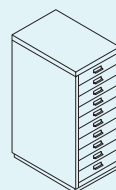

071/069

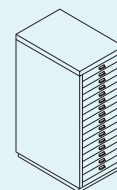

082/080

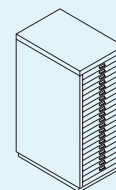

083/081

locking	non locking	description	drawer height	height	width	depth
187	185	29/8b multidrawer (2+3+3)*	25, 51, 102	670 (26.5")	279 (11")	408 (16")
063	061	29/5 multidrawer (5)*	102	670 (26.5")	279 (11")	408 (16")
067	065	29/6 multidrawer (6)*	87	670 (26.5")	279 (11")	408 (16")
087	085	29/8 multidrawer (8)*	64	670 (26.5")	279 (11")	408 (16")
071	069	29/10 multidrawer (10)*	51	670 (26.5")	279 (11")	408 (16")
082	080	29/16 multidrawer (16)*	30	670 (26.5")	279 (11")	408 (16")
083	081	29/20 multidrawer (20)*	25	670 (26.5")	279 (11")	408 (16")

* Number of drawers
29 series multidrawers are supplied with a plinth in black as standard (suffix code with 'P' for a matching colour)
Measurements in millimetres (approx. inches)

specifications: insert trays - see page 20, Section 2.3



- locking and non-locking units
- small part storage multi-compartment trays
- label holder on every drawer
- rubber 'feet' on desk mounted units

1. leveller base option
2. standard plinth for underdesk use
3. high plinth can be fitted to raise unit to support desks
4. castor bases can be fitted

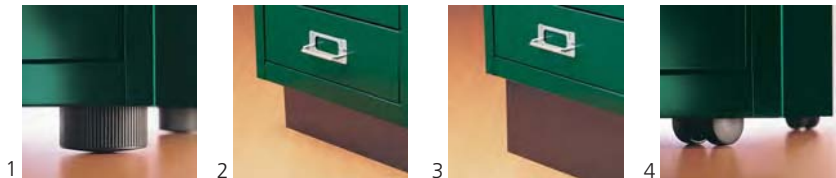

39 & A3 series multidrawers + optional extras



The 39 Series units make great storage units for office or home use. Available with a choice of 5 drawer 'heights' from 25mm to 87mm and multi-compartment insert trays for small item storage, the 39 Series is a flexible small office solution. 9 and 15 drawer A3 versions are also available.

The optional accessories for the Multidrawer range include:

Castor bases for 29 and 39 series, leveller bases for 29 and 39 series and a high plinth for 29 and 39 series. Multi-compartment trays are available from 4 to 35 compartments as well as A4 and A3 pen trays.

39 series multidrawers



103/101

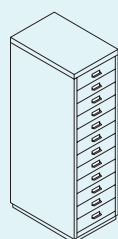

127/125

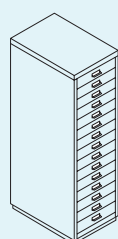

091/089

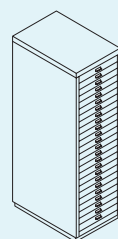

102/100

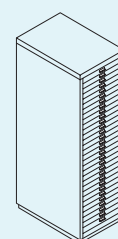

123/121

locking	non locking	description	drawer height	height	width	depth
103	101	39/9 multidrawer (9)*	87	940 (37")	279 (11")	408 (16")
127	125	39/12 multidrawer (12)*	64	940 (37")	279 (11")	408 (16")
091	089	39/15 multidrawer (15)*	51	940 (37")	279 (11")	408 (16")
102	100	39/24 multidrawer (24)*	30	940 (37")	279 (11")	408 (16")
123	121	39/30 multidrawer (30)*	25	940 (37")	279 (11")	408 (16")

* Number of drawers

39 series multidrawers are supplied with a plinth in black as standard (suffix code with 'P' for a matching colour)

Measurements in millimetres (approx. inches)

A3 series multidrawers (29 & 39 series)



113/112



2450/2440

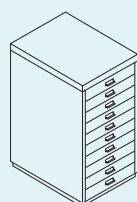

117/116



115/114

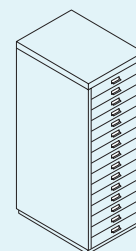

119/118

locking	non locking	description	drawer height	height	width	depth
113	112	BA3/6 (6)*	87	670 (26.5")	349 (13.7")	460 (18")
2450	2440	BA3/4 (1+3)*	51, 156	670 (26.5")	349 (13.7")	460 (18")
117	116	BA3/10 (10)*	51	670 (26.5")	349 (13.7")	460 (18")
115	114	BA3/9 (9)*	87	940 (37")	349 (13.7")	460 (18")
119	118	BA3/15 (15)*	51	940 (37")	349 (13.7")	460 (18")

* Number of drawers

A3 series multidrawers are supplied with a plinth in black as standard (suffix code with 'P' for a matching colour)

Measurements in millimetres (approx. inches)



- locking and non-locking units
- small part storage via multi-compartment trays
- castor bases can be fitted
- high plinth bases can be fitted to raise unit to support desks

1. easy media storage (BA3/4)
2. label holder on every drawer
3. 35 compartment insert tray
4. 16 compartment insert tray



BA3 single door locking cupboard

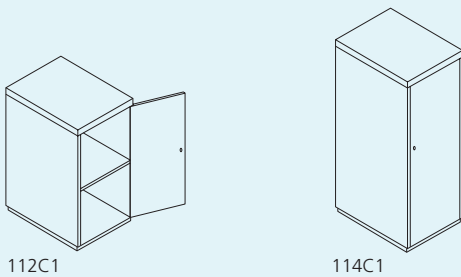

left hinge	right hinge	description	height	width	depth
112C1L	112C1	BA3/29 with one shelf	670 (26.5")	349 (13.7")	460 (18")
114C1L	114C1	BA3/39 with one shelf	940 (37")	349 (13.7")	460 (18")
BAS		extra shelf			

BA3 series multidrawers are supplied with a plinth in black as standard (suffix code with 'P' for a matching colour)
 Measurements in millimetres (approx. inches)

optional base

item	description	overall height of cabinet mm	
		29 series	39 series
CB2	castor base for 29 & 39 series	612 (24")	879 (34.5")
LBMD23	leveller base for 29 & 39 series	616-656 (24.25-25.8")	886-926 (34.9-36.5")
Suffix/7	high plinth for 29 & 39 series*	712 (28")	979 (38.5")
		BA3/6 BA3/4 BA3/10	BA3/9 BA3/15
CB3	castor base for A3 series	612 (24")	879 (34.5")
LBMDA3	leveller base for A3 series	616-656 (24.25-25.8")	886-926 (34.9-36.5")

* High plinth is factory fitted, speak to your Bisley Account Manager for details.
 Measurements in millimetres (approx. inches)

specifications: insert trays - see page 20, section 2.3

home multidrawers & insert trays



With a smaller footprint than standard multidrawers, lower heights and simpler configurations, the Home Multidrawers provide even better value storage. 6 units in total, the Home Multidrawers represent the most popular configurations from the 12, 29 and 39 Series.

Plastic insert trays can be fitted to all Bisley multidrawer units. Multiple height versions are available to match drawer heights.

home multidrawers

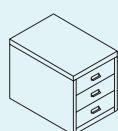

H123NL

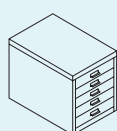

H125NL



H2910NL



H296NL



H298BNL

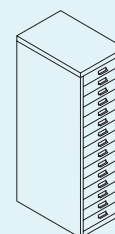

H3915NL

item	description	drawer height	height	width	depth
H123NL	home multidrawer (3)*	87	325 (12.7")	279 (11")	380 (15")
H125NL	home multidrawer (5)*	51	325 (12.7")	279 (11")	380 (15")
H2910NL	home multidrawer (10)*	51	590 (23.2")	279 (11")	380 (15")
H296NL	home multidrawer (6)*	87	590 (23.2")	279 (11")	380 (15")
H298BNL	home multidrawer (2+3+3)*	25, 51, 102	590 (23.2")	279 (11")	380 (15")
H3915NL	home multidrawer (15)*	51	860 (33.8")	279 (11")	380 (15")

* Number of drawers
CB5 castor base for home multidrawers
Measurements in millimetres (approx. inches)

insert trays



223P5

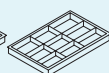

222P5

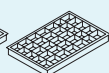

221P5

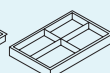

227P5

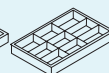

226P5

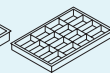

225P5

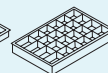

224P5

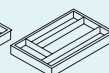

PIT580P5

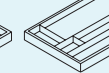

PIT450P5

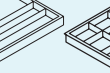

PIT451P5

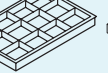

PIT522P5

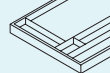

PIT522P5

item	description	height	compatible drawers
223P5	A4, 4 compartment tray (pack of 5)	22 (1")	all A4 drawers
222P5	A4, 9 compartment tray (pack of 5)	22 (1")	all A4 drawers
221P5	A4, 35 compartment tray (pack of 5)	22 (1")	all A4 drawers
227P5	A4, 4 compartment tray (pack of 5)	51 (2")	102, 87, 64, 51 deep, A4 drawers
226P5	A4, 9 compartment tray (pack of 5)	51 (2")	102, 87, 64, 51 deep, A4 drawers
225P5	A4, 16 compartment tray (pack of 5)	51 (2")	102, 87, 64, 51 deep, A4 drawers
224P5	A4, 24 compartment tray (pack of 5)	51 (2")	102, 87, 64, 51 deep, A4 drawers
PIT580P5	A4, pentray (pack of 5)	51 (2")	102, 87, 64, 51 deep, A4 drawers
PIT450P5	A3, pentray (pack of 5)	51 (2")	102, 87, 64, 51 deep, A3 drawers
PIT451P5	A3, 12 compartment tray (pack of 5)	83 (3.25")	156, 87 deep, A3 drawers
PIT522P5	F series, 5 compartment plastic insert tray (pack of 5)	83 (3.25")	F-series storage drawers

Measurements in millimetres (approx. inches)



- non locking
- smaller footprint (380mm deep)
- available in standard colours
- no plinth

1. 9 compartment insert tray
2. 24 compartment insert tray
3. 16 compartment insert tray
4. A4 pen tray



pfa home filer



An essential product for those seeking practical filing solutions with a small budget; Bisley 'home filers' are designed primarily for small office under desk storage. Five under desk and two taller cabinets are available in various combinations of stationery / media and filing drawers.

colour options

PFA home filers are finished in the following textured colours:

item	colour
v4	grey
v1	black
v4y8	grey/red duo
v4y7	grey/blue duo



pfa home filer

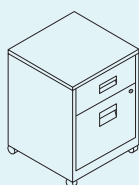

PFAM1S1F



PFAM3S



PFA4S

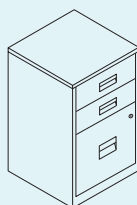

PFA3

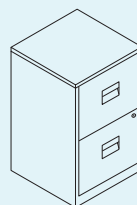

PFA2



PFA3F

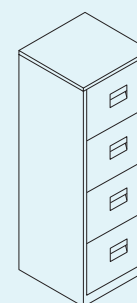

PFA4F

item	description	height	width	depth
PFAM1S1F	1 stationery, 1 filing drawer, mobile	521 (20.5")	413 (16.2")	400 (15.7")
PFAM3S	3 stationery drawers, mobile	521 (20.5")	413 (16.2")	400 (15.7")
PFA4S	4 stationery drawers	672 (26.5")	413 (16.2")	400 (15.7")
PFA3	2 stationery, 1 filing drawer	672 (26.5")	413 (16.2")	400 (15.7")
PFA2	2 filing drawers	672 (26.5")	413 (16.2")	400 (15.7")
PFA3F	3 filing drawers	1015 (40")	413 (16.2")	400 (15.7")
PFA4F	4 filing drawers	1282 (50.5")	413 (16.2")	400 (15.7")

Measurements in millimetres (approx. inches)
Subject to minimum order quantity (10)



- 'low' mobile versions
- 80% extension drawers
- locking
- optional pen tray
- large label holder

1. A4 suspension pockets
2. cd storage
3. stationery
4. pfa home filer colour palette



f-series & media storage cabinets



F Series filing cabinets provide complete flexibility for storing both A4 and Foolscap suspension files. 2 filing-drawers, 6 personal-drawers, 1 filing and 3 personal-drawer versions are available.

Bisley media storage cabinets are specifically designed to store CDs, DVDs and videos. Each drawer can be divided into three rows to accommodate up to 120 CDs, 54 DVDs or 26 videos.

All drawers are fitted with anti-tilt safety devices and ball bearing slides for smooth opening. The design also enables the plinth to be replaced with either castors or adjustable height levellers.

f series - flush front & classic front

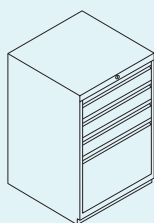

0503

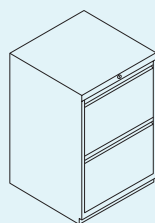

0463

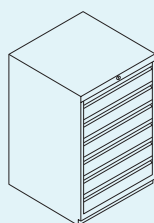

0493

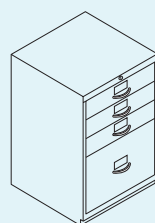

050

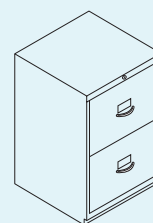

046

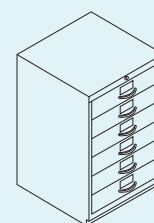

049

flush	classic	description	height	width	depth
0503	050*	1 filing and 3 storage drawers - 1F3E/1F3	711 (28")	470 (18.5")	470 (18.5")
0463	046*	2 filing drawers - 2FE/2F	711 (28")	470 (18.5")	470 (18.5")
0493	049*	6 storage drawers - F6E/F6	711 (28")	470 (18.5")	470 (18.5")
PIT522P5		5 compartment plastic insert tray fits storage drawers - pack of 5 (see page 20, section 2.3)			
CB1		castor base for all units (please specify if factory fitted)			

* Classic style handles

f series cabinets are supplied with a plinth in black as standard (suffix code with 'P' for a matching colour)

Measurements in millimetres (approx. inches)

media storage cabinets

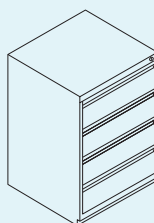

MS4E

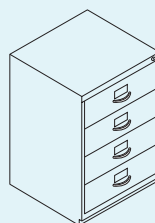

MS4C

flush	classic	description	height	width	depth
MS4E	MS4C*	4 drawers - empty	711 (28")	498 (19.5")	470 (18.5")
MSVP		video pack - 4 dividers / 8 compressor plates			
MSCDP		cd pack - 8 dividers / 12 compressor plates			
MSDP4		dividers - pack of 4			
CB4		castor base - please specify if factory fitted (single pack)			

* Classic style handles

media storage cabinets are supplied with a plinth in black as standard (suffix code with 'P' for a matching colour)

Measurements in millimetres (approx. inches)



- 100% extension drawers
- drawer interlock
- classic or flush front
- mastered lock, 200 differs

1. optional castor base
2. optional leveller base
3. compressor plates
4. insert tray

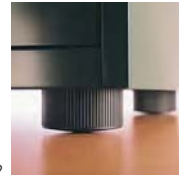

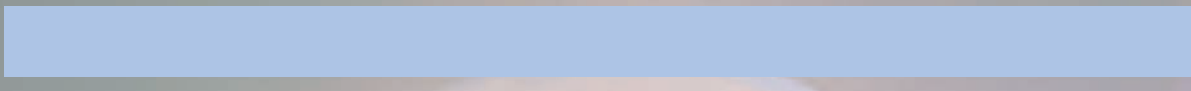

- 3.1 A0 plan files
- 3.1 A1 plan files
- 3.2 card filing cabinets
- 3.2 card index cabinets



divided to conquer

Bisley's specialist document storage range is designed for maximum versatility and capacity across a range of media sizes; specific product variants provide practical and logical filing from A7 to A0.



A0 & A1 plan files



The renowned Bisley Plan File is still a common sight in design offices and studios across Europe and even though fewer large format documents are stored in this way, there is still a requirement for protected, practical storage of drawings, plans, samples and collections. Bisley plan files are available in five or ten drawer units and either A0 or A1 size; intermediate five drawer sections are also available to further increase capacity.

A0 plan files

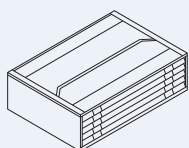

460

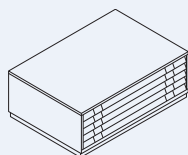

463

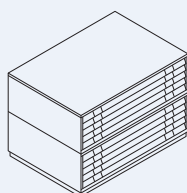

461/462

item	description	height	width	depth
460	FCB 41 - 5 drawer intermediate section only	406 (16")	1359 (53.5")	927 (36.5")
463	FCB 40 - 5 drawer unit complete with top and plinth	508 (20")	1359 (53.5")	927 (36.5")
461/462	FCB 33 - 10 drawer unit complete with top and plinth	914 (36")	1359 (53.5")	927 (36.5")
PFD	plan file dividers (pack of 2)			

plan files are supplied with a plinth in black as standard (suffix code with 'P' for a matching colour)
Measurements in millimetres (approx. inches)

A1 plan files

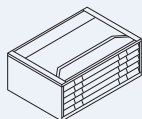

470

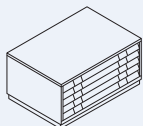

473

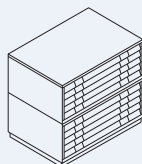

471/472

item	description	height	width	depth
470	FCB 44 - 5 drawer unit intermediate section only	406 (16")	1010 (39.7")	691 (27.2")
473	FCB 43 - 5 drawer unit complete with top and plinth	508 (20")	1010 (39.7")	691 (27.2")
471/472	FCB 42 - 10 drawer unit complete with top and plinth	914 (36")	1010 (39.7")	691 (27.2")
PFD	plan file dividers (pack of 2)			

plan files are supplied with a plinth in black as standard (suffix code with 'P' for a matching colour)
Measurements in millimetres (approx. inches)



- A0 drawers are tested to an evenly distributed load of 50kg (25kg A1 drawers)
- Stack plan files up to 15 drawers, adding capacity at a later date

1. two large label holders per drawer
2. master lock, 200 differs
3. all drawers fitted with pressure bar and hood to prevent creasing and curling
4. all drawers are slotted and can be subdivided into other A sizes



1

2

3

4



card filing & card index cabinets



The Bisley range of card filing cabinets can accommodate up to 4600 cards per drawer but is also suitable for archive media storage such as CDs, DVDs and videos. Each drawer can be subdivided for efficient filing, features a positive closing device and is mounted on ball bearing rollers for smooth operation even when fully loaded.

Small and compact, card index cabinets are a cost-effective method of storing card-based information immediately to hand. Robust and secure single and double versions are available for 5"x3", 6"x4" and 8"x5" cards.

card filing cabinets

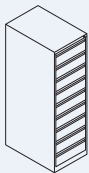

B64
card size: 152 x 102 (6x4")

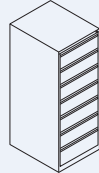

B85
card size: 203 x 127 (8x5")

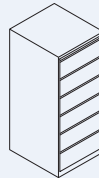

B96
card size: 228 x 152 (9x6")

item	description	capacity			height	width	depth
		cards	cds	videos			
B64	BCF64 - card filing cabinet (9)*	41,400	-	-	1321 (52")	413 (16.2")	622 (24.5")
B85	BCF85 - card filing cabinet (7)*	32,200	-	294	1321 (52")	518 (20.3")	622 (24.5")
B85CD	CD cabinet (7)*	-	1113	-	1321 (52")	518 (20.3")	622 (24.5")
B96	BCF96 - card filing cabinet (6)*	27,600	960	252	1321 (52")	568 (22.3")	622 (24.5")

Additional compressor plates (sold in packs of ten) for **8346P10** - B64 plates, **8347P10** - B85 plates, **8348P10** - B96 plates and **CPB85CDP10** - B85CD plates.

* Number of drawers

Measurements in millimetres (approx. inches)

card index cabinets



128/A7HS



129/A6HS



130/A5HS



131/A7HD



132/A6HD



133/A5HD

imperial/metric	description	card sizes	height	width	depth
128/A7HS	FCB13 - card index cabinet (1)*	5 x 3" (A7)	133 (5.2")	192 (7.5")	403 (16")
129/A6HS	FCB14 - card index cabinet (1)*	6 x 4" (A6)	159 (6.2")	217 (8.5")	403 (16")
130/A5HS	FCB15 - card index cabinet (1)*	8 x 5" (A5)	206 (8")	271 (10.7")	403 (16")
131/A7HD	FCB23 - card index cabinet (2)*	5 x 3" (A7)	133 (5.2")	384 (15")	403 (16")
132/A6HD	FCB24 - card index cabinet (2)*	6 x 4" (A6)	159 (6.2")	434 (17")	403 (16")
133/A5HD	FCB25 - card index cabinet (2)*	8 x 5" (A5)	206 (8")	542 (21.5")	403 (16")

Each drawer will accommodate approx. 1,500 new cards. Each lock per drawer **022**. Add L to code for factory fitted lock.

Additional compressor plates (sold in packs of ten) for **138P10** = 5 x 3 (A7), **1381P10** = 6 x 4 (A6), **1382P10** = 8 x 5 (A5) * Number of drawers

Measurements in millimetres (approx. inches)



- all drawers can be subdivided
- drawer interlock on B85 and B96
- card file can be secured together for stability

1. index cards
2. digital media
3. mastered lock, 200 differs
4. two large label holders

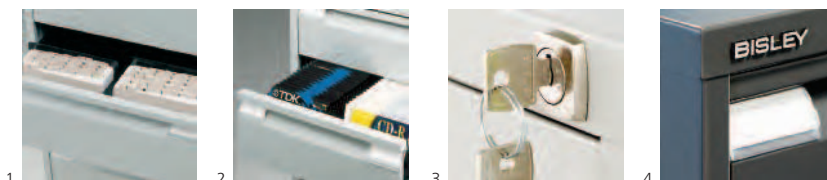

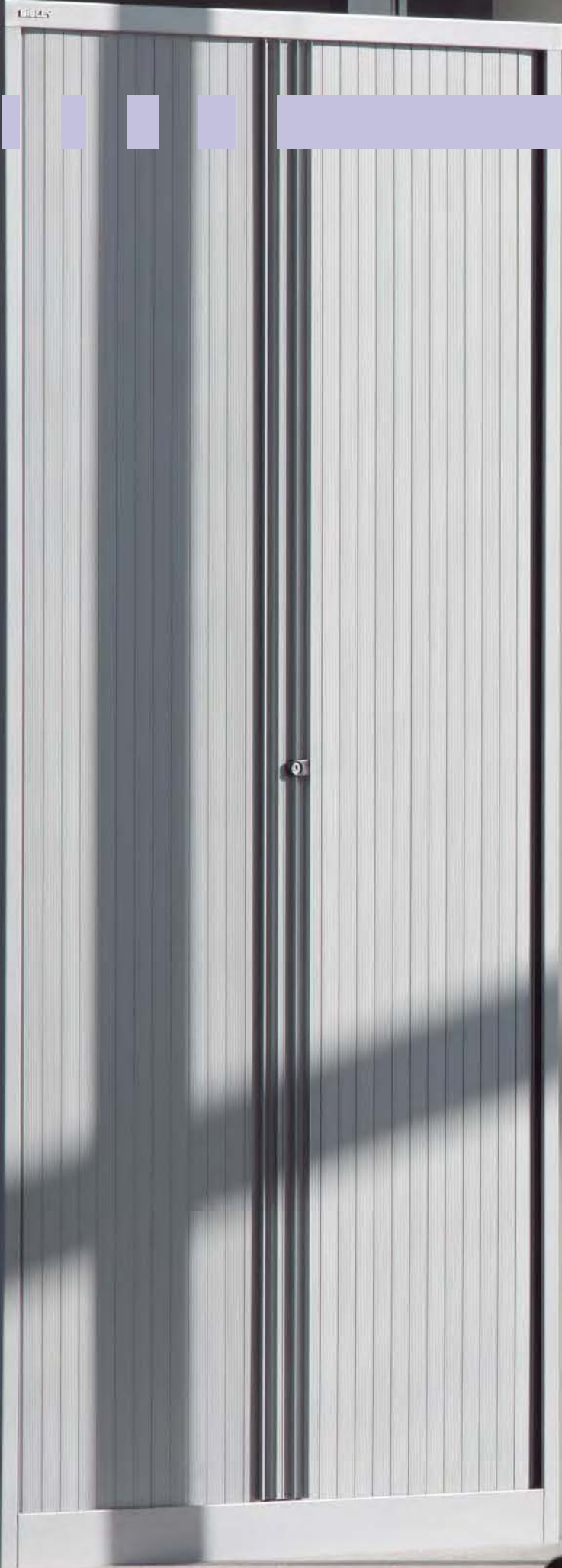

- 4.1 two door cupboards
- 4.1 open front cupboards
- 4.2 stationery cupboards
- 4.3 side opening tambours
- 4.3 cupboard fitments
- 4.4 contract side opening tambours
- 4.4 safety warning for cupboards
- 4.5 A4 eurotambours
- 4.6 lockers
- 4.7 static shelving



vertical spaces sorted

Bisley tambour and two door cupboards enable maximum vertical space utilisation and offer a selection of cabinet heights to suit media and location. Bisley make it easy to plan storage to the needs of a particular application; a comprehensive range of internal fittings is available for the filing and storage requirements of every office.



two door & open front cupboards



The ubiquitous, all purpose Bisley cupboard is available both fully assembled or in flat-pack screwdriver-assembly form for those out-of-the-way corners of the building. Available in four heights to suit location and storage requirements, a range of cupboard fittings is available including 'pigeon holes' and 'wardrobe packs'.

two door cupboards

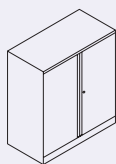

A402W11

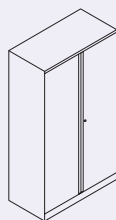

A652W00

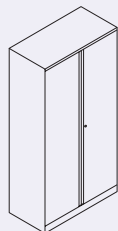

A722W00

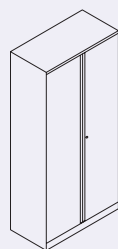

A782W00

item	description	modules*	height	width	depth
A402W11:45	two door cupboard with one shelf (grey)	37	1016 (40")	914 (36")	457 (18")
A402W11:33	two door cupboard with one shelf (black)	37	1016 (40")	914 (36")	457 (18")
A652W00	two door cupboard empty	64	1651 (65")	914 (36")	457 (18")
A722W00	two door cupboard empty	71	1806 (71")	914 (36")	457 (18")
A782W00	two door cupboard empty	78	1968 (77.5")	914 (36")	457 (18")

KD cupboards available.

Measurements in millimetres (approx. inches)

See page 38 section 4.3 for internal options

* Modules refer to modular capacity

open front cupboards

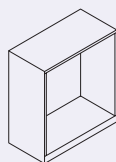

A400W11

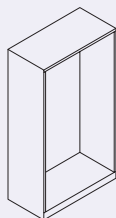

A650W00

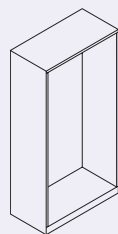

A720W00

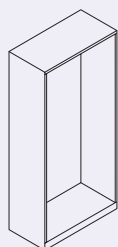

A780W00

item	description	modules*	height	width	depth
A400W11	open cupboard with one shelf	37	1016 (40")	914 (36")	457 (18")
A650W00	open cupboard empty	64	1651 (65")	914 (36")	457 (18")
A720W00	open cupboard empty	71	1806 (71")	914 (36")	457 (18")
A780W00	open cupboard empty	78	1968 (77.5")	914 (36")	457 (18")

KD cupboards available.

Measurements in millimetres (approx. inches)

See page 38 section 4.3 for internal options

* Modules refer to modular capacity



- magnetic latching
- 2 point locking
- flush-handle design
- standard, slotted or universal shelves

1. undershelf filing
2. slotted shelves
3. plain shelf
4. pigeon holes

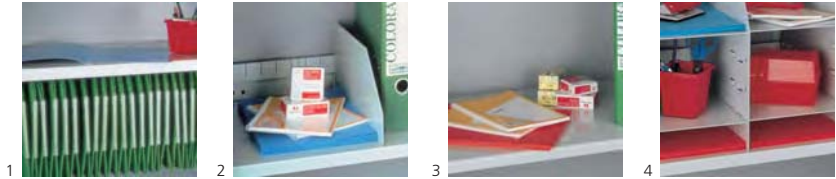

stationery cupboards



Bisley stationery cupboards are designed for maximum storage capacity but are economical on space. In recognition of the fact that multiple different office items need to be stored behind closed doors, stationery cupboards do not accommodate suspension filing frames but provide a space efficient solution to most on shelf filing requirements and undershelf lateral filing. Bisley stationery cupboards are part of the Bisley 'fast track' range of affordable 'storage essentials' available on quick delivery.

stationery cupboards

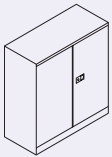

E402A01

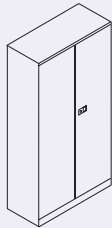

E722A03

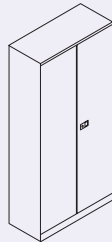

E782A04

item	description	height	width	depth
E402A01	stationery cupboard with one black filing shelf	1000 (39.5")	914 (36")	400 (15.7")
E722A03	stationery cupboard with three black filing shelves	1806 (71")	914 (36")	400 (15.7")
E782A04	stationery cupboard with four black filing shelves	1950 (76.5")	914 (36")	400 (15.7")
E198P1:33	additional dual purpose shelf - black			

These cupboards are designed to accommodate a dual purpose shelf / with undershelf filing (330mm centre). ref **E198P1:33**

Colours: stationery cupboards are finished in textured colours: goose grey, light grey, black & coffee/cream duo.

Measurements in millimetres (approx. inches)



- supplied complete with dual purpose shelves
- three-point locking mechanism for security
- unobtrusive integrated handle
- hard wearing textured paint finish

1. dual purpose shelf
2. smaller footprint
3. mastered lock, 200 differs
4. fast track colour palette



side opening tambour cupboards



Bisley's range of versatile Side Opening Tambour Cupboards has been designed to maximise storage capacity and make the most of valuable office space; because tambour doors retract into the cupboard side, they use up less space.

A comprehensive range of internal fittings enables efficient storage for every application.

side opening tambours

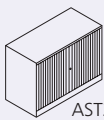

AST28W

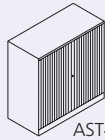

AST40W

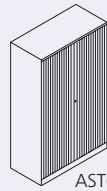

AST65W

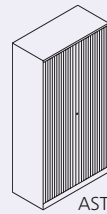

AST78W

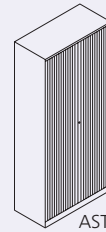

AST87W

item	description	modules*	height	width	depth
AST28W	tambour cupboard empty	26	711 (28")	1000 (39.5")	470 (18.5")
AST40W	tambour cupboard empty	39	1016 (40")	1000 (39.5")	470 (18.5")
AST65W	tambour cupboard empty	66	1651 (65")	1000 (39.5")	470 (18.5")
AST78W	tambour cupboard empty	80	1968 (77.5")	1000 (39.5")	470 (18.5")
AST87W	tambour cupboard empty	92	2229 (87.7")	1000 (39.5")	470 (18.5")

KD tambours available. (457mm deep only). Shutter colours available in light grey (1), dark grey (9), black (5), cream (2) & silver (SL). Measurements in millimetres (approx. inches). * Modules refer to modular capacity.

cupboard fittings

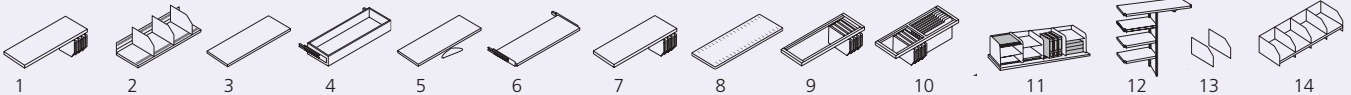

item	modules*	description
1. 198P1:45	13'	shelf with undershelf filing (A4) - files with 330mm centre - grey
1. 198P1:33	13'	shelf with undershelf filing (A4) - files with 330mm centre - black
2. BSS	1'	slotted shelf (single pack) (for use with metal dividers, BSDP5)
2. BSDP5	6	slotted shelf dividers (set of 5)
3. BBSP1:45	1'	standard shelf (single pack) grey
3. BBSP1:33	1'	standard shelf (single pack) black
4. RODWR4	5	roll-out drawer (single pack) 102mm (4" deep) (slotted for use with metal divider, BDD3P5)
4. BDD3P5	-	drawer dividers (set of 5)
5. BWS	-	wardrobe shelf (single pack)
6. ROSH	3	roll-out shelf (single pack)
7. BUS1	13'	undershelf lateral filing (single pack)
8. BSSPDP1:33	-	new slotted shelf - black (for use with plastic dividers, SHDU85P5PS)
8. BSSPDP1:45	-	new slotted shelf - grey (for use with plastic dividers, SHDU85P5PS)
9. BUR	13	lateral filing rail (single pack) (A4) adjustable lateral file (range 190-330mm)
10. ROSFF	12	roll-out suspension filing frame (single pack) (foolscap side facing or 2 rows of foolscap or A4 front facing)
11. BPH	14'	pigeon hole (single pack) (includes shelf dividers and intershelves)
11. PHSP8	-	intershelves (pack of 8)
12. BWP	-	wardrobe pack for 78" cupb + 78" & 87" side tamb
13. SHDU85P5PS	-	plastic shelf dividers (pack of 5)
14. PGNHLESET	-	pigeon hole set**
BAB457	-	height adjustable base for 457mm deep cupboard
BAB470	-	height adjustable base for 470mm deep cupboard

* Modules refer to modular capacity. (1 module = 23mm) * Allow for items to be stored on or in the internal fitment. All roll-out fitments include an interlock system for safety. See page 40, section 4.4 for safety warning. Cupboard fitments are available in grey or black.

** Pigeon hole set contains: 5 plastic dividers, 8 plastic intermediate shelves and 4 plastic back plates (slotted shelf not included)



- approved to BS EN 14073: pts 2+3 & BS EN 14074
- using AST87 and side access media up to 5.88 linear metres of storage is available
- ideal for roll-out cupboard fitments such as filing frames and drawers
- all roll-out fitments are supplied with an interlock for safety
- all fitments are available in light grey or black

1. roll-out filing frame
2. roll-out drawer
3. roll-out reference shelf
4. lateral rail

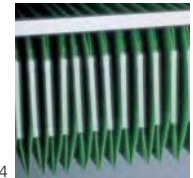
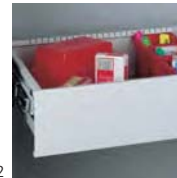

contract side opening tambours



The CST tambour cupboard represents great value and flexibility for office storage. With a limited range of cabinet sizes and internals, the CST tambour cupboards are part of the Bisley 'fast track' range of affordable 'storage essentials' available on quick delivery.

contract side opening tambour

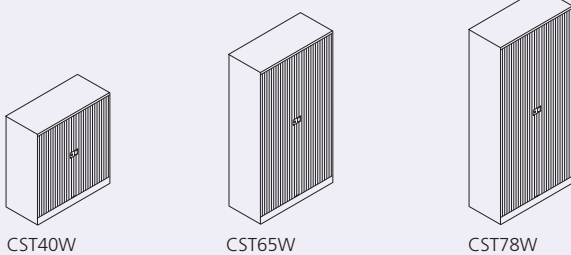

item	description	modules*	height	width	depth
CST40W	tambour cupboard empty	39	1016 (40")	1000 (39.5")	470 (18.5")
CST65W	tambour cupboard empty	66	1651 (65")	1000 (39.5")	470 (18.5")
CST78W	tambour cupboard empty	80	1968 (77.5")	1000 (39.5")	470 (18.5")

Colours: available in textured goose grey with light grey (1) tambours or coffee with cream (2) tambours on fast turnaround also available in smooth black with black (5) tambours and silver with silver (SL) tambours on standard lead time
Measurements in millimetres (approx. inches)

internal fitments for side opening tambours

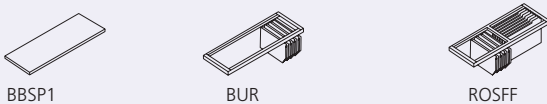

item	modules*	description
BBSP1:45	1	standard shelf grey
BUR	13	lateral filing rail (single pack) (A4) adjustable lateral file (range 190-330mm)
ROSFF	12	roll-out suspension filling frame (single pack) (foolscap side-to-side or 2 rows of foolscap or A4 front to back)

* Modules refer to modular capacity. (1 module = 23mm) * Allow for items to be stored on or in the internal fitment. All roll-out fitments include an interlock system for safety.
Measurements in millimetres (approx. inches)
Fitments supplied in grey only

safety warning

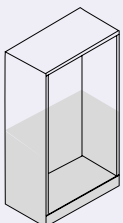

Roll out fitments must only be fitted in the bottom half of any Bisley Storage unit.

With the exception of the 87 high Tambour units where no more than 3 roll outs are recommended.

For your Safety ensure that:

1. Storage cupboards are positioned on a level floor surface.
2. All roll-out accessories are fitted in the lower half of the unit.
3. If more than one roll-out is used, the supplied interlock should be fitted.
4. No roll-out fitments are stood or leaned on.
5. All fitments are installed from the base upwards.

Consult your Bisley Dealer if in any doubt.



- approved to BS EN 14073: pts 2+3 & BS EN 14074
- using CST78 and side access media more than 5 linear metres of storage is available
- ideal for roll-out storage using filing frames

1. shelf
2. lateral rail
3. roll-out frame
4. available in textured goose grey with light grey tambours or coffee with cream tambours

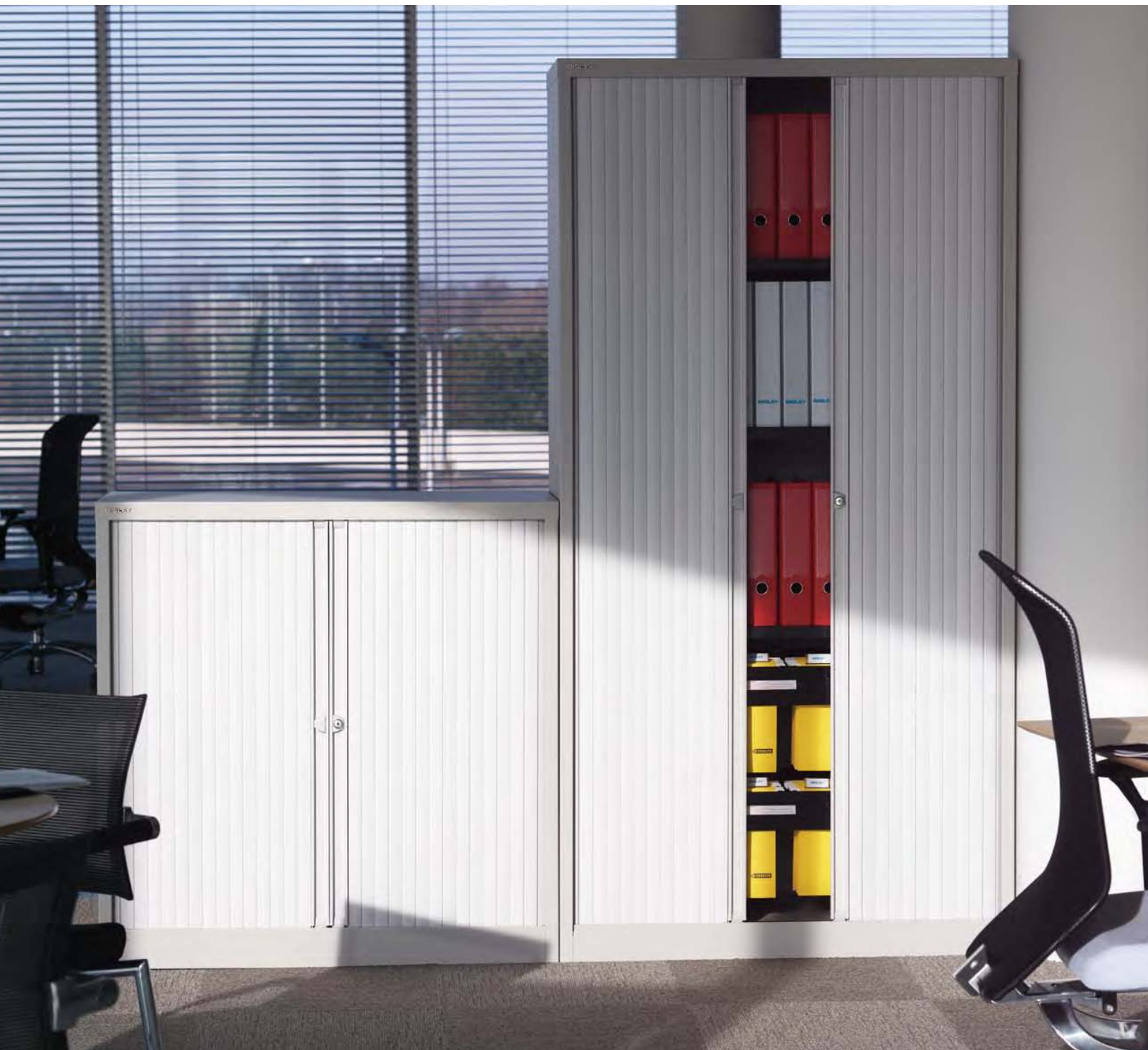
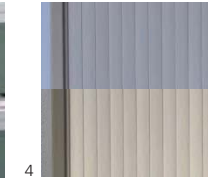
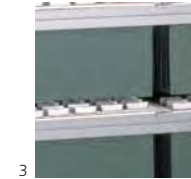
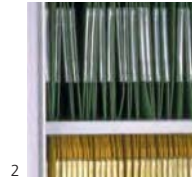

A4 eurotambours



Designed specifically to a European format, Eurotambours provide optimum filing capacity for A4 size media. An expansive range of cabinet sizes and internal fittings enables efficient storage for selected filing applications.

A4 eurotambours

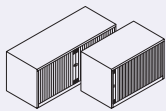

ET410/TB.* ET408/TB.*
ET412/TB.*

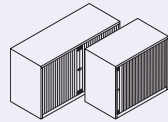

ET410/06.* ET408/06.*
ET412/06.*

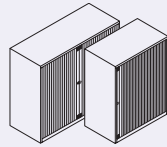

ET410/10.* ET408/10.*
ET412/10.*

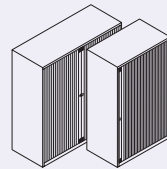

ET410/13.* ET408/13.*
ET412/13.*

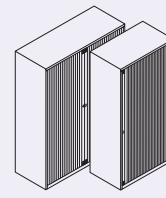

ET410/16.* ET408/16.*
ET412/16.*

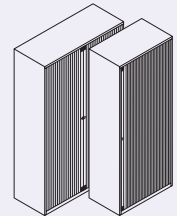

ET410/19.* ET408/19.*
ET412/19.*

-A4 eurotambour, complete units-

Dimensions

- A4 eurotambour, empty-

single tambour

double tambour

item	description	modules**	height	width†	depth†	item (empty)
ET408/TB.*	'top box'	-	495 (19.5")	800 (31.5")	430 (17")	-
ET408/06/1S.*	1 shelf	28	695 (27.3")	800 (31.5")	430 (17")	ET408/06.*
ET408/10/2S.*	2 shelves	47	1030 (40.5")	800 (31.5")	430 (17")	ET408/10.*
ET408/13/3S.*	3 shelves	63	1330 (52.4")	800 (31.5")	430 (17")	ET408/13.*
ET408/16/3S.*	3 shelves	77	1600 (63")	800 (31.5")	430 (17")	ET408/16.*
ET408/19/4S.*	4 shelves	97	1980 (78")	800 (31.5")	430 (17")	ET408/19.*
ET410/TB.*	'top box'	-	495 (19.5")	1000 (39.5")	430 (17")	-
ET410/06/1S.*	1 shelf	28	695 (27.3")	1000 (39.5")	430 (17")	ET410/06.*
ET410/10/2S.*	2 shelves	47	1030 (40.5")	1000 (39.5")	430 (17")	ET410/10.*
ET410/13/3S.*	3 shelves	63	1330 (52.4")	1000 (39.5")	430 (17")	ET410/13.*
ET410/16/3S.*	3 shelves	77	1600 (63")	1000 (39.5")	430 (17")	ET410/16.*
ET410/19/4S.*	4 shelves	97	1980 (78")	1000 (39.5")	430 (17")	ET410/19.*
ET412/TB.*	'top box'	-	495 (19.5")	1200 (47.2")	430 (17")	-
ET412/06/1S.*	1 shelf	28	695 (27.3")	1200 (47.2")	430 (17")	ET412/06.*
ET412/10/2S.*	2 shelves	47	1030 (40.5")	1200 (47.2")	430 (17")	ET412/10.*
ET412/13/3S.*	3 shelves	63	1330 (52.4")	1200 (47.2")	430 (17")	ET412/13.*
ET412/16/3S.*	3 shelves	77	1600 (63")	1200 (47.2")	430 (17")	ET412/16.*
ET412/19/4S.*	4 shelves	97	1980 (78")	1200 (47.2")	430 (17")	ET412/19.*

* Add digits for Shutter Colours available in light grey (LG) dark grey (9), black (5), cream (2), silver (SL), beech (BC) and white (EW)
Measurements in millimetres (approx. inches)

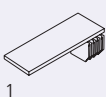

1

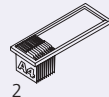

2

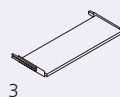

3

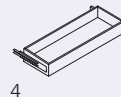

4

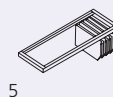

5

description	modules**	800mm wide	1000mm wide	1200mm wide
1. shelf with undershelf filing	16 [†]	ET408SHPS	ET410SHPS	ET412SHPS
2. roll-out filing frame for A4 / foolscap suspension pockets***	14	ET408RFPS	ET410RFPS	ET412RFPS
3. roll-out shelf	4	ET408RSPS	ET410RSPS	ET412RSPS
4. roll-out 100mm (4") drawer	7 [†]	ET408RD4PS	ET410RD4PS	ET412RD4PS
5. lateral filing rail (single pack) (A4) adjustable lateral file (range 190-330mm)	16	ET408LRPS	ET410LRPS	ET412LRPS

** Modules refer to modular capacity. (1 module = 19mm) [†] Allow for items to be stored on or in the internal fitment. All roll-out fitments include an interlock system for safety.

*** One set of cross rails are included

Fitments supplied in black only

Measurements in millimetres (approx. inches)



- designed for A4 filing, but will take foolscap front facing
- smaller footprint (430mm deep)
- multiple cabinet heights and widths enable optimum configurations
- ideal for roll-out cupboard fitsments such as A4 filing frames and media drawers
- 1000mm wide unit accommodates 2 rows of foolscap filing (front facing)

1. roll-out filing frame
2. approved to BS EN 14073: pts 2+3 & BS EN 14074
3. dual purpose shelf
4. roll-out reference shelf



1



2



3

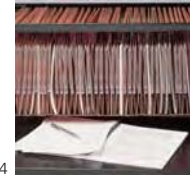

4



storage lockers



Bisley lockers provide a functional yet stylish solution for secure personal storage in commercial or public premises. The range incorporates two depths of locker (305mm and 457mm) with a choice of single, two, four and six door compartments.

Additional design features include an under shelf coat hook in two door lockers, with an under shelf coat rail for multiple hangers in the single door locker.

lockers

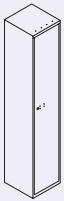

CLK121



CLK122



CLK124



CLK126



CLK181



CLK182

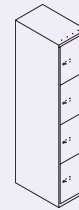

CLK184

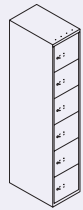

CLK186

item	description	internal compartment			external dimension		
		height	width	depth	height	width	depth
CLK121	1 door locker	1703	240	274	1802 (71")	305 (12")	305 (12")
CLK122	2 door locker	847	240	274	1802 (71")	305 (12")	305 (12")
CLK124	4 door locker	416 & 404*	240	274	1802 (71")	305 (12")	305 (12")
CLK126	6 door locker	275 & 263*	240	274	1802 (71")	305 (12")	305 (12")
CLK181	1 door locker	1703	240	426	1802 (71")	305 (12")	457 (18")
CLK182	2 door locker	847	240	426	1802 (71")	305 (12")	457 (18")
CLK184	4 door locker	416 & 404*	240	426	1802 (71")	305 (12")	457 (18")
CLK186	6 door locker	275 & 263*	240	426	1802 (71")	305 (12")	457 (18")
BLLP1	Hasp lock, supplied seperately as retro fitted option						

* Where 2 internal heights are listed, the first is for the top and the bottom compartments only. Measurements in millimetres (approx. inches)



- lockers are fitted with a camlock - Hasp locks are optional
- each locker has ventilation holes in the top and base of the carcass

1. card holder on every door
2. approved to BS EN 14073: pts 2+3 & BS EN 14074
3. mastered lock, 2000 differs
4. bolt together back and sides



static shelving



A range of versatile shelving that can be organised to suit your space requirements exactly. Fully pocketed shelf clips and smooth, roll formed edges ensure a safe storage environment for people and materials.

Starter and extension kits enable you to build complete systems or cost effectively add storage at a later date. Six shelf units are 1827mm high and three shelf units are 1107mm high; available with 300 or 400mm deep shelves.

static shelving

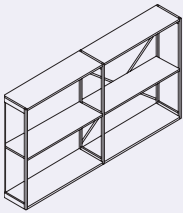

1 x BRSTK33
1 x BREXK33

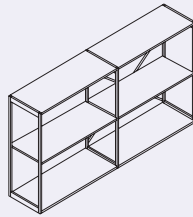

1 x BRSTK43
1 x BREXK43

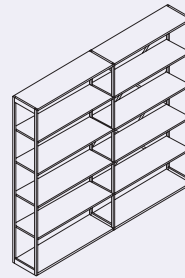

1 X BRSTK36
1 X BREXK36

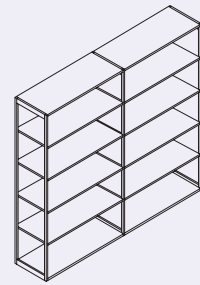

1 X BRSTK46
1 X BREXK46

item	description	kit contains	height	width	depth
BRSTK33	starter kit	2 x frame, 3 x shelf, 1 x cross bracing kit	1107 (43.5")	1000 (39")	300 (11.8")
BREXK33	extension kit	1 x frame, 3 x shelf	1107 (43.5")	1000 (39")	300 (11.8")
BRSTK43	starter kit	2 x frame, 3 x shelf, 1 x cross bracing kit	1107 (43.5")	1000 (39")	400 (15.7")
BREXK43	extension kit	1 x frame, 3 x shelf	1107 (43.5")	1000 (39")	400 (15.7")
BRCBK3	extra bracing kit				
BRSTK36	starter kit	2 x frame, 6 x shelf, 1 x cross bracing kit	1827 (72")	1000 (39")	300 (11.8")
BREXK36	extension kit	1 x frame, 6 x shelf	1827 (72")	1000 (39")	300 (11.8")
BRSTK46	starter kit	2 x frame, 6 x shelf, 1 x cross bracing kit	1827 (72")	1000 (39")	400 (15.7")
BREXK46	extension kit	1 x frame, 6 x shelf	1827 (72")	1000 (39")	400 (15.7")
BRCBK6	extra bracing kit				

Measurements in millimetres (approx. inches)

An extender offer is now available, please speak to your Bisley representative regarding other options



- available in light grey only
- quick and easy to assemble – only one screw
- 90kg load capacity per shelf
- extra bracing is only required every other shelving bay

1. move or add extra shelves easily
2. extend side to side and back to back
3. designed to SEMA & FEM code of practice
4. 400mm deep dual purpose shelf

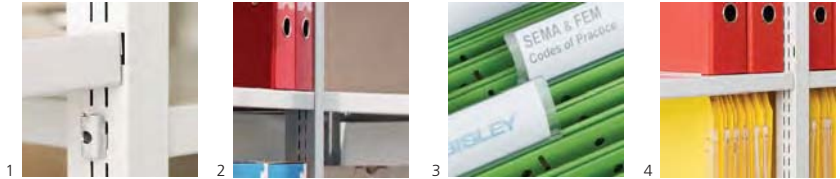



- 5.1 bite®
- 5.2 towers
- 5.3 note pedestals
- 5.4 wave pedestals



desk bound

Bisley has developed a comprehensive range of desk storage to be incorporated with any desk product. Carcasses are precision engineered from one piece steel wraps with no visible seams and offer exceptional strength characteristics.





Bite® is a mobile storage unit that wraps around bench desking and workstations, providing not only capacious multi-functional storage, but also creating a sense of personal space within the open plan working environment.

A multitude of features include an upper cantilevered secure compartment, a letter box for receiving mail and a lid which opens up to create a mini-screen that can be specified with a bulletin board or whiteboard. The upper and lower elements bridge the worksurface, providing space-efficient and ergonomically-sound storage immediately to hand.



BTBACPLWIIF



BTBACPLBIIF



BTBACPRBMF



BTBACPRWMF

item	description	height	width	depth
BTBACPLBIIF	left handed, pin-able board, 2 intermediate & 1 filing drawer	930 (37")	428 (17")	573 (23")
BTBACPLBMF	left handed, pin-able board, 1 medium & 1 filing drawer	930 (37")	428 (17")	573 (23")
BTBACPLWIIF	left handed, whiteboard, 2 intermediate & 1 filing drawer	930 (37")	428 (17")	573 (23")
BTBACPLWMF	left handed, whiteboard, 1 medium & 1 filing drawer	930 (37")	428 (17")	573 (23")
BTBACPRBIIF	right handed, pin-able board, 2 intermediate & 1 filing drawer	930 (37")	428 (17")	573 (23")
BTBACPRBMF	right handed, pin-able board, 1 medium & 1 filing drawer	930 (37")	428 (17")	573 (23")
BTBACPRWIIF	right handed, whiteboard, 2 intermediate & 1 filing drawer	930 (37")	428 (17")	573 (23")
BTBACPRWMF	right handed, whiteboard, 1 medium & 1 filing drawer	930 (37")	428 (17")	573 (23")
DIP	drop-in pen tray (A4) ordered separately			

European Community Design Registration No. 000871066-0002
 International Patent Application No. PCT/GB2009/000076
 The whiteboards and pin-able boards are interchangeable after delivery
 The lids are changeable from left handed to right handed and vice versa
 Measurements in millimetres (approx. inches)



- creating personal space in the open plan office
- capacious multifunctional storage
- castors, locking in front
- space-efficient and ergonomically sound design

1. postal slot and business card holder
2. reversible soft closing lid
3. bulletin board or whiteboard
4. medium drawer



towers



Bisley Pedestal Towers is a range of integrating desk storage elements designed around the concept that personal storage cannot be pre-defined and what people store on-and-around their desk changes with every desk. Bisley address this need, but also recognise the need for formality and tidiness.

Available in different heights and configurations, 'Towers' provides adaptable spaces for filing, desk accessories, storage of personal items and the ability to quickly 'lock up the laptop' or maintain a clean desk.

towers

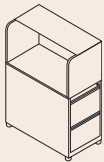

TWRBOX & TWRPEDIFF

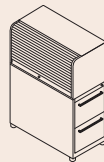

TWRTAM.SL & TWRPEDHEFF

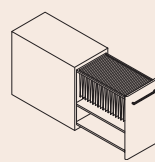

BTW2ZRFS

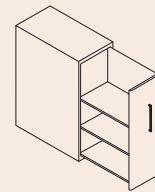

BTW3BR2S

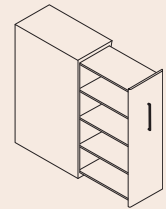

BTW4BR4S

item	description	height	width	depth
TWRBOX	open storage box at desk height			
TWRPEDIFF	free standing pedestal, 2 filing drawers, recessed handles	1100 (43")	420 (16.5")	800 (31.5")
TWRBOX	open storage box at desk height			
TWRPEDHEFF	free standing pedestal, 2 filing drawers, applied handles	1100 (43")	420 (16.5")	800 (31.5")
TWRBOX	open storage box at desk height			
TWRPEDISSF	free standing pedestal, 2 stationery, 1 filing drawer, recessed handles	1100 (43")	420 (16.5")	800 (31.5")
TWRBOX	open storage box at desk height			
TWRPEDHESSF	free standing pedestal, 2 stationery, 1 filing drawer, applied handles	1100 (43")	420 (16.5")	800 (31.5")
TWRTAM.SL	locking tambour storage box at desk height	1100 (43")	420 (16.5")	800 (31.5")
TWRPEDIFF	free standing pedestal, 2 filing drawers, recessed handles	1100 (43")	420 (16.5")	800 (31.5")
TWRTAM.SL	locking tambour storage box at desk height	1100 (43")	420 (16.5")	800 (31.5")
TWRPEDHEFF	free standing pedestal, 2 filing drawers, applied handles	1100 (43")	420 (16.5")	800 (31.5")
TWRTAM.SL	locking tambour storage box at desk height	1100 (43")	420 (16.5")	800 (31.5")
TWRPEDISSF	free standing pedestal, 2 stationery, 1 filing drawer, recessed handles	1100 (43")	420 (16.5")	800 (31.5")
TWRTAM.SL	locking tambour storage box at desk height	1100 (43")	420 (16.5")	800 (31.5")
TWRPEDHESSF	free standing pedestal, 2 stationery, 1 filing drawer, applied handles	1100 (43")	420 (16.5")	800 (31.5")
BTW2ZRFS*	tower 2, no top panel, file rail, 1 adjustable shelf	698 (27.5")	420 (16.5")	800 (31.5")
BTW3BR2S*	tower 3, 18mm top panel, 2 adjustable shelves	1100 (43")	450 (18")	840 (33")
BTW3BRLS*	tower 3, 18mm top panel, tool ladder, 1 adjustable shelf	1100 (43")	450 (18")	840 (33")
BTW4BR4S*	tower 4, 18mm top panel, 4 adjustable shelves	1300 (51")	450 (18")	840 (33")
DSB2	drop-in storage bin (1/2 module)			
DSB4	drop-in storage bin (1/4 module)			
SRSTW234	sliding reference shelf			

* Right handed units are shown, replace **R** with **L** for left handed units e.g. BTW4BR4S = right handed, BTW4BL4S = left handed
Measurements in millimetres (approx. inches)



- extensive colour palette
- configurations to suit your application
- optional work surfaces, tool ladders and fabric pin boards
- free storage for personal items

1. topbox
2. configurable with matching work surface
3. pinable screen
4. screen compatible tool ladder



note pedestals



The clean line of the Bisley Note pedestal is a significant pointer to the compelling, practical design of this Bisley pedestal range. The 'one-piece wrap' and welded carcass is embedded with our newest assembly technology and the neutral, rectilinear aesthetic takes its cues from the latest furniture styles. The Note pedestal compliments a wide range of personal and shared desking solutions.

Two carcass widths provided for forward-facing A4 suspension file storage or 'narrow footprint' side facing suspension filing. 5th castors or counterbalances are included automatically with mobile pedestals.

note pedestal



NWA59M7SF NWA59M7SSS NW359M7SF NW359M7SSS NWA5AM7IIF NWA52M7FF NWA52M7SSF NW352M7FF NW352M7SSF NWA53G7FF NWA53G7SSF
 NWA59M1SF NWA59M1SSS NW359M1SF NW359M1SSS NWA5AM1IIF NWA52M1FF NWA52M1SSF NW352M1FF NW352M1SSF NWA53G1FF NWA53G1SSF

code	description	height	width	depth
NWA59M7SF	mobile (1 stationery & 1 filing drawer) with 5th castor	495 (19.5")	420 (16.5")	565 (22.2")
NWA59M7SSS	mobile (3 stationery drawers)	495 (19.5")	420 (16.5")	565 (22.2")
NW359M7SF	mobile (1 stationery & 1 filing drawer) with 5th castor	495 (19.5")	300 (11.8")	565 (22.2")
NW359M7SSS	mobile (3 stationery drawers)	495 (19.5")	300 (11.8")	565 (22.2")
NWA5AM7IIF	mobile (2 intermediate & 1 filing drawer) with 5th castor	565 (22.2")	420 (16.5")	565 (22.2")
NWA52M7FF	mobile (2 filing drawers) including counterweight	645 (25.3")	420 (16.5")	565 (22.2")
NWA52M7SSF	mobile (2 stationery & 1 filing drawer) with 5th castor	645 (25.3")	420 (16.5")	565 (22.2")
NW352M7FF	mobile (2 filing drawers) including counterweight	645 (25.3")	300 (11.8")	565 (22.2")
NW352M7SSF	mobile (2 stationery & 1 filing drawer) with 5th castor	645 (25.3")	300 (11.8")	565 (22.2")
NWA53G7FF	free standing/desk supporting (2 filing drawers)	698 - 731 (27.5-28.8")	420 (16.5")	565 (22.2")
NWA53G7SSF	free standing/desk supporting (2 stationery & 1 filing drawer)	698 - 731 (27.5-28.8")	420 (16.5")	565 (22.2")

DIP drop-in pen tray (A4) can be ordered separately

1** 6mm over-sailing decorative steel top (add 6mm to overall height)

** To add a 'steel top' to any note pedestal, replace '7' with '1' in code (adds 6mm to pedestal height)

e.g. NWA59M1SF mobile pedestal as above with added 6mm decorative steel top

Measurements in millimetres (approx. inches)



- 5 year Bisley guarantee
- robust, 'vertical wrap', welded steel carcase
- tested to BS EN 14073: Part 3
- drawer interlock – only single drawer opening at a time

1. Optional 6mm decorative steel top
2. 100% extension file drawers
3. optional drop-in pen tray
4. 5th castor for stability on all filing drawers



wave pedestals



Stylish and strong, Wave is a completely new range of Bisley pedestals featuring all the popular pedestal variants. Soft, sculptured lines and a distinctive integrated handle provide a flowing aesthetic specifically designed to complement modern desking applications... but the appeal of Wave pedestals goes deeper; innovative drawer front design hides a fail-safe drawer interlock and embedded drawer alignment for easy operation, whilst the latest manufacturing technology delivers a robust carcass.

Two carcass widths provide for forward-facing A4 suspension file storage or 'narrow footprint' side facing suspension filing. Skids or counterbalances are included automatically with mobile pedestals.

wave pedestals



WVA59MSF



WVA59MSSS

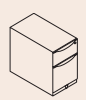

WV359MSF



WV359MSSS



WVA52MFF

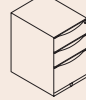

WVA52MSSF

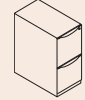

WV352MFF

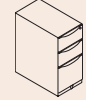

WV352MSSF

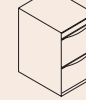

WVA53GFF

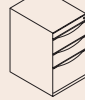

WVA53GSSF

item	description	height	width	depth
WVA59MSF	mobile (1 stationery & 1 filing drawer) with skid	495 (19.5")	420 (16.5")	565 (22.2")
WVA59MSSS	mobile (3 stationery drawers)	495 (19.5")	420 (16.5")	565 (22.2")
WV359MSF	mobile (1 stationery & 1 filing drawer) with skid	495 (19.5")	300 (11.8")	565 (22.2")
WV359MSSS	mobile (3 stationery drawers)	495 (19.5")	300 (11.8")	565 (22.2")
WVA52MFF	mobile (2 filing drawers) including counterweight	645 (25.3")	420 (16.5")	565 (22.2")
WVA52MSSF	mobile (2 stationery & 1 filing drawer) with skid	645 (25.3")	420 (16.5")	565 (22.2")
WV352MFF	mobile (2 filing drawers) including counterweight	645 (25.3")	300 (11.8")	565 (22.2")
WV352MSSF	mobile (2 stationery & 1 filing drawer) with skid	645 (25.3")	300 (11.8")	565 (22.2")
WVA53GFF	free standing/desk supporting (2 filing drawers)	698-731 (27.5-28.8")	420 (16.5")	565 (22.2")
WVA53GSSF	free standing/desk supporting (2 stationery & 1 filing drawer)	698-731 (27.5-28.8")	420 (16.5")	565 (22.2")

DIP Drop-in prentry (A4) ordered separately

Measurements in millimetres (approx. inches)



- 5 year Bisley guarantee
- robust, 'vertical wrap', welded steel carcass
- approved to BS EN 14073: pts 2+3 & BS EN 14074
- drawer interlock – only single drawer opening at a time

1. integrated handle design
2. 100% extension file drawers
3. optional drop-in pen tray
4. file drawer 'skid' for stability





- 6.1 systemfile combination units
- 6.2 systemfile tambour cupboards
- 6.2 systemfile two door cupboards
- 6.3 systemfile - combination (individually locking)
- 6.3 systemfile - interior components
- 6.4 systemfile - internal specifications
- 6.4 systemfile - vertical capacities
- 6.5 InnerSpace



solutions found

Multiple storage solutions exist within a single range; Bisley have developed both cabinets and mobile shelving that offer huge flexibility in terms of widths, heights (and depths in the case of InnerSpace), which together with clever use of internals means that powerful solutions can be provided without complexity.

Sympathetic design and precision manufacture ensure a high quality product and an impressive office environment.



systemfile - combination unit



Bisley SystemFile is an attractive high density storage solution. A comprehensive cabinet range with multiple height, width & closure options. Combinations of drawers, flippers, cupboard or tambour doors with a wide range of internal fittings, make SystemFile extremely versatile.

systemfile combination units

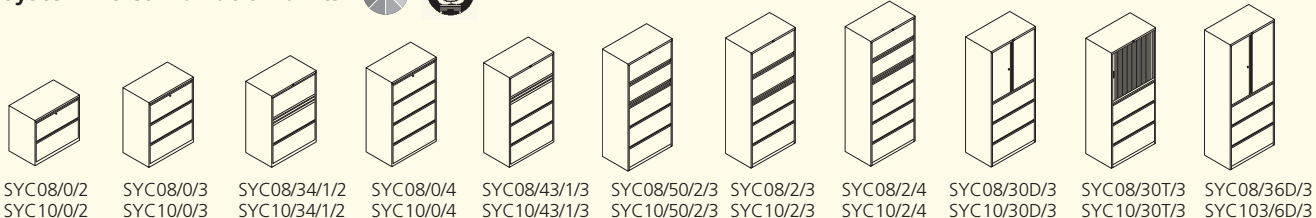

item	description	height	width	depth
SYC08/0/2	2 drawers & counterbalance	693-717 (27.2-28.2")	800 (31.5")	470 (18.5")
SYC08/0/3	3 drawers & counterbalance	997-1021 (39.2-40.2")	800 (31.5")	470 (18.5")
SYC08/34/1/2	1 x 418mm (16.5") flipper, 2 drawers & counterbalance	1149 -1173 (45.2-46.2")	800 (31.5")	470 (18.5")
SYC08/0/4	4 drawers & counterbalance	1301-1325 (51.2-52.2")	800 (31.5")	470 (18.5")
SYC08/43/1/3	1 x 381mm (15") flipper, 3 drawers & counterbalance	1415 -1439 (55.7-56.7")	800 (31.5")	470 (18.5")
SYC08/50/2/3	2 x 305mm (12") flippers, lateral rails, 3 drawers & counterbalance	1643 -1667 (64.7-65.7")	800 (31.5")	470 (18.5")
SYC08/2/3	2 x 381mm (15") flippers, narrow basic shelf & 3 drawers	1793-1817 (70.5-71.5")	800 (31.5")	470 (18.5")
SYC08/2/4	2 x 305mm (12") flippers, lateral rails & 4 drawers	1947-1971 (76.5-77.5")	800 (31.5")	470 (18.5")
SYC08/30D/3	762mm (30") doors, 1 adjustable shelf & 3 drawers	1793-1817 (70.5-71.5")	800 (31.5")	470 (18.5")
SYC08/30T.*/3	762mm (30") tambour, 1 adjustable shelf & 3 drawers	1793-1817 (70.5-71.5")	800 (31.5")	470 (18.5")
SYC08/36D/3	915mm (36") doors, 1 adjustable shelf & 3 drawers	1947-1971 (76.5-77.5")	800 (31.5")	470 (18.5")
SYC10/0/2	2 drawers & counterbalance	693-717 (27.2-28.2")	1000 (39.5")	470 (18.5")
SYC10/0/3	3 drawers & counterbalance	997-1021 (39.2-40.2")	1000 (39.5")	470 (18.5")
SYC10/34/1/2	1 x 418mm (16.5") flipper, 2 drawers & counterbalance	1149 -1173 (45.2-46.2")	1000 (39.5")	470 (18.5")
SYC10/0/4	4 drawers & counterbalance	1301-1325 (51.2-52.2")	1000 (39.5")	470 (18.5")
SYC10/43/1/3	1 x 381mm (15") flipper, 3 drawers & counterbalance	1415 -1439 (55.7-56.7")	1000 (39.5")	470 (18.5")
SYC10/50/2/3	2 x 305mm (12") flippers, lateral rails, 3 drawers & counterbalance	1643 -1667 (64.7-65.7")	1000 (39.5")	470 (18.5")
SYC10/2/3	2 x 381mm (15") flippers, shelf & 3 drawers	1793-1817 (70.5-71.5")	1000 (39.5")	470 (18.5")
SYC10/30D/3	762mm (30") doors, 1 adjustable shelf & 3 drawers	1793-1817 (70.5-71.5")	1000 (39.5")	470 (18.5")
SYC10/30T.*/3	762mm (30") tambour, 1 adjustable shelf & 3 drawers	1793-1817 (70.5-71.5")	1000 (39.5")	470 (18.5")
SYC10/2/4	2 x 305mm (12") flippers, lateral rails & 4 drawers	1947-1971 (76.5-77.5")	1000 (39.5")	470 (18.5")
SYC10/36D/3	915mm (36") doors, 1 adjustable shelf & 3 drawers	1947-1971 (76.5-77.5")	1000 (39.5")	470 (18.5")

* Add digits for Shutter Colours available in light grey (1), dark grey (9), black (5), cream (2), white (EW), silver (SL) and beech (BC)
 Top panel is 472mm deep. All drawers include a file bar and two cross rails. Adjustable levelling feet fitted as standard
 Measurements in millimetres (approx. inches)



- eight carcass heights from 695 mm to 1950mm
- carcass widths 800 & 1000mm
- drawers have file bars and cross rails for side to side or front to back filing of A4 and foolscap and foolscap

1. side filers
2. combination flipper / drawers
3. cupboard / drawers
4. tambour / drawers



systemfile - tambour & 2 door cupboards



SystemFile tambour and 2 door cupboards enable multiple storage formats to be stored behind a single elegant closure; SystemFile tambours feature smooth slat and matching handrail, SystemFile 2 door cupboards utilise a flush-front, full-height integrated handle design.

systemfile tambour cupboards

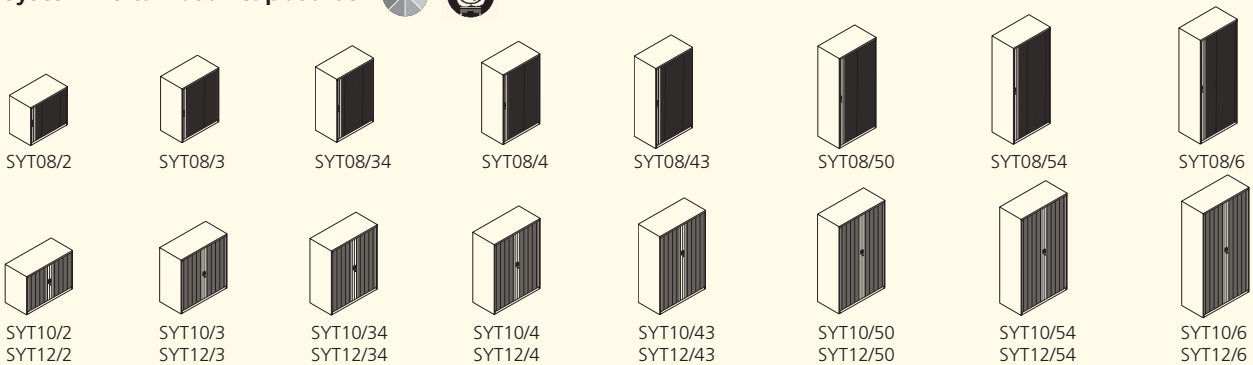

item	description	modules	height	width	depth
SYT08/2.*	single tambour	32	693-717 (27.2-28.2")	800 (31.5")	470 (18.5")
SYT08/3.*	single tambour	48	997-1021 (39.2-40.2")	800 (31.5")	470 (18.5")
SYT08/34.*	single tambour	55	1149 -1173 (45.2-46.2")	800 (31.5")	470 (18.5")
SYT08/4.*	single tambour	64	1301-1325 (51.2-52.2")	800 (31.5")	470 (18.5")
SYT08/43.*	single tambour	69	1415 -1439 (55.7-56.7")	800 (31.5")	470 (18.5")
SYT08/50.*	single tambour	81	1643 -1667 (64.7-65.7")	800 (31.5")	470 (18.5")
SYT08/54.*	single tambour	90	1793-1817 (70.5-71.5")	800 (31.5")	470 (18.5")
SYT08/6.*	single tambour	98	1947-1971 (76.5-77.5")	800 (31.5")	470 (18.5")
SYT10/2.*	double tambour	32	693-717 (27.2-28.2")	1000 (39.5")	470 (18.5")
SYT10/3.*	double tambour	48	997-1021 (39.2-40.2")	1000 (39.5")	470 (18.5")
SYT10/34.*	double tambour	55	1149 -1173 (45.2-46.2")	1000 (39.5")	470 (18.5")
SYT10/4.*	double tambour	64	1301-1325 (51.2-52.2")	1000 (39.5")	470 (18.5")
SYT10/43.*	double tambour	69	1415 -1439 (55.7-56.7")	1000 (39.5")	470 (18.5")
SYT10/50.*	double tambour	81	1643 -1667 (64.7-65.7")	1000 (39.5")	470 (18.5")
SYT10/54.*	double tambour	90	1793-1817 (70.5-71.5")	1000 (39.5")	470 (18.5")
SYT10/6.*	double tambour	98	1947-1971 (76.5-77.5")	1000 (39.5")	470 (18.5")
SYT12/2.*	double tambour	32	693-717 (27.2-28.2")	1200 (47.2")	470 (18.5")
SYT12/3.*	double tambour	48	997-1021 (39.2-40.2")	1200 (47.2")	470 (18.5")
SYT12/34.*	double tambour	55	1149 -1173 (45.2-46.2")	1200 (47.2")	470 (18.5")
SYT12/4.*	double tambour	64	1301-1325 (51.2-52.2")	1200 (47.2")	470 (18.5")
SYT12/43.*	double tambour	69	1415 -1439 (55.7-56.7")	1200 (47.2")	470 (18.5")
SYT12/50.*	double tambour	81	1643 -1667 (64.7-65.7")	1200 (47.2")	470 (18.5")
SYT12/54.*	double tambour	90	1793-1817 (70.5-71.5")	1200 (47.2")	470 (18.5")
SYT12/6.*	double tambour	98	1947-1971 (76.5-77.5")	1200 (47.2")	470 (18.5")

* Add digits for Shutter Colours available in light grey (1), dark grey (9), black (5), cream (2), white (EW), silver (SL) and beech (BC)
Measurements in millimetres (approx. inches)



- eight carcass heights from 695mm to 1950mm
- two (three) carcass widths 800, 1000 & 1200mm (tambours only)
- magnetic latching and multipoint locking

1. tambour handle detail
2. 2-door cupboard handle detail
3. approved to BS EN 14073: pts 2+3 & BS EN 14074
4. all units have height adjustable levelling feet



systemfile two door cupboards

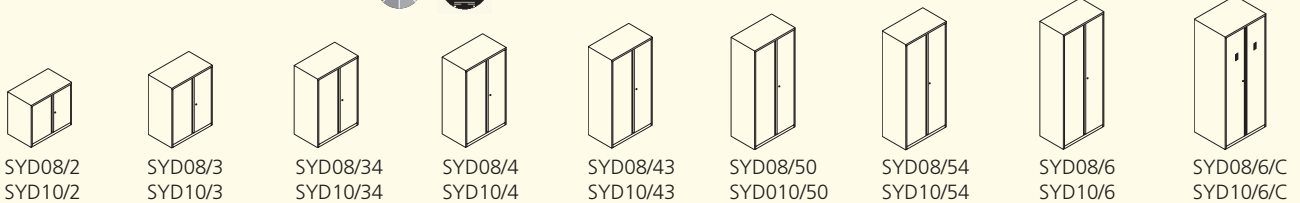

item	description	modules	height	width	depth
SYD08/2	two door cupboard	32	693 - 717 (27.2 - 28.2")	800 (31.5")	470 (18.5")
SYD08/3	two door cupboard	48	997 - 1021 (39.2 - 40.2")	800 (31.5")	470 (18.5")
SYD08/34	two door cupboard	55	1149 - 1173 (45.2 - 46.2")	800 (31.5")	470 (18.5")
SYD08/4	two door cupboard	64	1301 - 1325 (51.2 - 52.2")	800 (31.5")	470 (18.5")
SYD08/43	two door cupboard	69	1415 - 1439 (55.7 - 56.7")	800 (31.5")	470 (18.5")
SYD08/50	two door cupboard	81	1643 - 1667 (64.7 - 65.7")	800 (31.5")	470 (18.5")
SYD08/54	two door cupboard	90	1793 - 1817 (70.5 - 71.5")	800 (31.5")	470 (18.5")
SYD08/6	two door cupboard	98	1947 - 1971 (76.5 - 77.5")	800 (31.5")	470 (18.5")
SYD08/6/C	ventilated doors (includes shelf with coat rail)	-	1947 - 1971 (76.5 - 77.5")	800 (31.5")	600 (23.5")
SYD10/2	two door cupboard	32	693 - 717 (27.2 - 28.2")	1000 (39.5")	470 (18.5")
SYD10/3	two door cupboard	48	997 - 1021 (39.2 - 40.2")	1000 (39.5")	470 (18.5")
SYD10/34	two door cupboard	55	1149 - 1173 (45.2 - 46.2")	1000 (39.5")	470 (18.5")
SYD10/4	two door cupboard	64	1301 - 1325 (51.2 - 52.2")	1000 (39.5")	470 (18.5")
SYD10/43	two door cupboard	69	1415 - 1439 (55.7 - 56.7")	1000 (39.5")	470 (18.5")
SYD10/50	two door cupboard	81	1643 - 1667 (64.7 - 65.7")	1000 (39.5")	470 (18.5")
SYD10/54	two door cupboard	90	1793 - 1817 (70.5 - 71.5")	1000 (39.5")	470 (18.5")
SYD10/6	two door cupboard	98	1947 - 1971 (76.5 - 77.5")	1000 (39.5")	470 (18.5")
SYD10/6/C	ventilated doors (includes shelf with coat rail)	-	1947 - 1971 (76.5 - 77.5")	1000 (39.5")	600 (23.5")

Top panel is 472mm deep. Adjustable levelling feet fitted as standard. Two door cupboards are supplied empty, see page 65, section 6.3 for internal fittings
Measurements in millimetres (approx. inches)

systemfile - combination (individually locking) & interior con



SystemFile tambour and 2 door cupboards can be specified to meet your exact needs. The comprehensive choice of internal fitments means that SystemFile is particularly suited to general storage and filing solutions.

systemfile combination units with individually locking drawers



SYCI08/20/0/2
SYCI10/20/0/2



SYCI08/30/0/3
SYCI10/30/0/3



SYCI08/40/0/4
SYCI10/40/0/4

item	description	height	width	depth
SYCI08/20/0/2	2 drawers with security drawer divider plates	693-717 (27.2-28.2")	800 (31.5")	470 (18.5")
SYCI08/30/0/3	3 drawers with security drawer divider plates	997-1021 (39.2-40.2")	800 (31.5")	470 (18.5")
SYCI08/40/0/4	4 drawers with security drawer divider plates	1301-1325 (51.2-52.2")	800 (31.5")	470 (18.5")
SYCI10/20/0/2	2 drawers with security drawer divider plates	693-717 (27.2-28.2")	1000 (39.5")	470 (18.5")
SYCI10/30/0/3	3 drawers with security drawer divider plates	997-1021 (39.2-40.2")	1000 (39.5")	470 (18.5")
SYCI10/40/0/4	4 drawers with security drawer divider plates	1301-1325 (51.2-52.2")	1000 (39.5")	470 (18.5")

Top panel is 472mm deep. All drawers include two file bars and two cross rails. Adjustable levelling feet and counterbalance fitted as standard. Measurements in millimetres (approx. inches)



- all internals supplied in black
- all roll-out components are supplied with an interlock for safety

1. roll-out filing frame
2. slotted shelf
3. roll-out media drawer
4. lateral rail

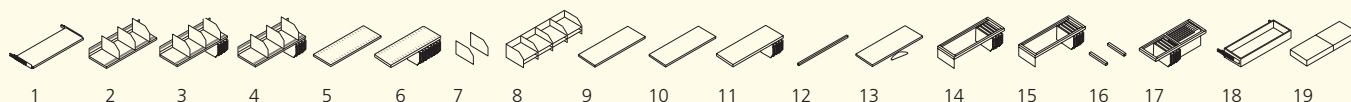
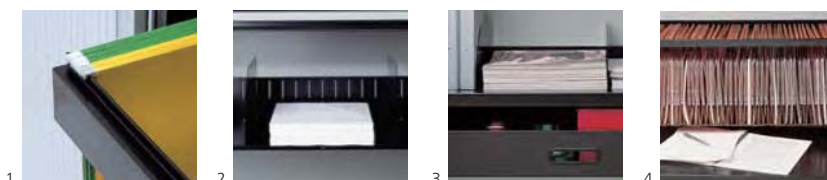

combination units & two door cupboards - interior components

description	modules	800mm wide	1000mm wide
2. slotted shelf	2	BIC08SSPS	BIC10SSPS
3. slotted shelf with undershelf filing	16	BIC08SSUPS	BIC10SSUPS
4. narrow slotted shelf for A4 undershelf filing	16	BIC08NSSPS	BIC10NSSPS
2/3/4. shelf dividers (pack of 3)	-	BIADSP3PS	BIADSP3PS
5. new slotted shelf (for use with plastic dividers)	2	BIC08SSPDPS:T5	BIC10SSPDPS:T5
6. new slotted shelf with undershelf filing	16	BIC08SSUPDPS:T5	BIC10SSUPDPS:T5
7. plastic shelf dividers (pack of 5)	-	SHDV65P5PS	SHDV65P5PS
8. pigeon hole set**	17	PGNHLESET	PGNHLESET
9. narrow shelf	2	BIC08NBSPS	BIC10NBSPS
10. shelf 32mm	2	BIC08BSPS:T5	BIC10BSPS:T5
11. shelf with undershelf filing (adjustable)	16	BIC08BSUPS	BIC10BSUPS
12. file bar (1 needed per drawer)	-	BIC08FBPS	BIC10FBPS
13. coat rail - front to back with shelf	-	BIC08CRPS	BIC10CRPS
14. lateral rail for 12" flipper door	16	BIC08LRFPS	BIC10LRFPS
15. lateral rail	16	BIC08LRPS	BIC10LRPS
16. cross rails for front to back suspension filing	-	BICCRPS	BICCRPS

tambour units - interior components

description	modules	800mm wide	1000mm wide	1200mm wide
1. roll-out shelf	3	BIT08RSPS	BIT10RSPS	BIT12RSPS
2. slotted shelf	2	BIT08SSPS	BIT10SSPS	BIT12SSPS
3. slotted shelf with undershelf filing	16	BIT08SSUPS	BIT10SSUPS	BIT12SSUPS
2/3. shelf dividers (pack of 3)	-	BIADSP3PS	BIADSP3PS	BIADSP3PS
5. new slotted shelf	2	BIT08SSPDPS:T5	BIT10SSPDPS:T5	BIT12SSPDPS:T5
6. new slotted shelf with undershelf filing	16	BIT08SSUPDPS:T5	BIT10SSUPDPS:T5	BIT12SSUPDPS:T5
7. plastic shelf dividers (pack of 5)	-	SHDV65P5PS	SHDV65P5PS	SHDV65P5PS
8. pigeon hole set**	17	PGNHLESET	PGNHLESET	PGNHLESET
10. shelf 32mm	2	BIT08BSPS:T5	BIT10BSPS:T5	BIT12BSPS:T5
11. shelf with undershelf filing (adjustable)	16	BIT08BSUPS	BIT10BSUPS	BIT12BSUPS
13. coat rail - front to back with shelf	-	BIT08CRPS	BIT10CRPS	BIT12CRPS
15. lateral rail	16	BIT08LRPS	BIT10LRPS	BIT12LRPS
16. cross rails for front to back suspension filing	-	BITCRPS	BITCRPS	BITCRPS
17. roll-out filing frame	15	BIT08RFAPS	BIT10RFAPS	BIT12RFAPS
18. roll-out 4" drawer	6	BIT08RDAPS	BIT10RDAPS	BIT12RDAPS
- 4" drawer dividers (3 pack)	-	BIAD4P3PS	BIAD4P3PS	BIAD4P3PS
19. counterbalance*	-	BIACB08PS	BIACB10PS	BIACB12PS

All interior components are supplied in black

* Recommended for all units up to 1340mm in height

** Pigeon hole set contains: 5 plastic dividers, 8 plastic intermediate shelves and 4 plastic back plates (slotted shelf not included)

systemfile - internal specification & capacities



SystemFile tambour and 2 door cupboards can be specified to meet your exact needs. The comprehensive choice of internal fittings means that SystemFile is particularly suited to general storage and filing solutions.

SystemFile is available with an extensive range of internal fittings for Tambours and 2-Door cupboards.

The tables illustrate the modular capacity of 2-Door Cupboards, Tambours, and internal fittings. Modular capacity refers to the total internal space available for storage where 1 module = 19mm.

All internals are supplied in black.

modular capacities for tambours and two door cupboards

tambour	2 door cupboards	height	tambours	cupboards
SYT**/6	SYD**/6	1947 - 1971	97	98
SYT**/54	SYD**/54	1793 - 1817	89	90
SYT**/50	SYD**/50	1643 - 1667	81	81
SYT**/43	SYD**/43	1415 - 1439	69	69
SYT**/4	SYD**/4	1301 - 1325	63	64
SYT**/34	SYD**/34	1149 - 1173	55	55
SYT**/3	SYD**/3	997 - 1021	47	48
SYT**/2	SYD**/2	693 - 717	31	32

** For all widths

modular requirements for tambours and two door cupboards

internals	modules
shelves	2
slotted shelves & dividers	2 + 8
new slotted shelves with pigeon hole set	17
shelf & undershelf filing	16
lateral rails	16
roll-out filing frame	-
roll-out drawer	-
roll-out shelf	-

A. lateral rails

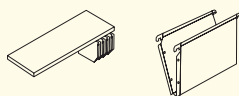

Lateral rails and shelves with undershelf filing with lateral files up to 275mm require 16 modules.

B. roll-out filing frames

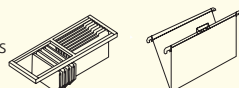

Roll-out filing frames with suspension files up to 245mm require 15 modules.

C. shelving

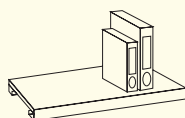

Make sure you allow enough space for the height of the tallest item to be stored on the shelf.

C = height of item to be stored. To calculate modules divide C by 19mm and round-up.

systemfile planning guide - vertical capacities

min height (mm):	693	997	1149	1301	1415	1643	1793	1947
max height (mm):	717	1021	1173	1325	1439	1667	1817	1971
modular height:	20	30	34	40	43	50	54	60

A4 BOX FILES



FOOLSCAP BOX FILES



A4 LEVER-ARCH FILES



FOOLSCAP LEVER-ARCH FILES



LATERAL FILING

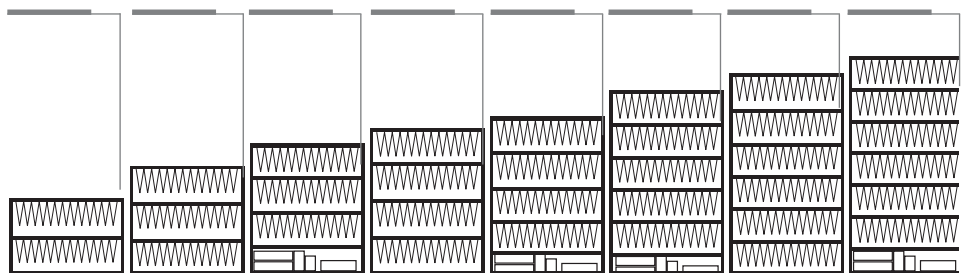

Please see page 70 for dimensions of soft storage products, these may differ between manufacturers

InnerSpace



Bisley InnerSpace is a high-density storage system designed specifically for the front office, releasing space where it's needed most.

Easy to specify, easy to install and easy to reconfigure, InnerSpace enables users to gain maximum storage capacity in the minimum floor space.

InnerSpace is available in either a "Deck" (sits on top of existing floor) or "Access" (incorporated in a raised access floor system) version.

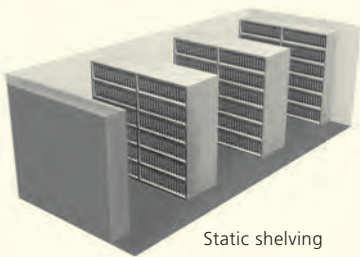

Static shelving

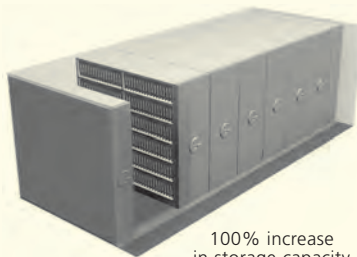

100% increase in storage capacity

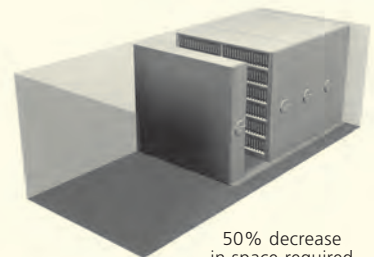

50% decrease in space required

InnerSpace



Bay widths: 800, 1000, 1200mm

Max no. bays: 6

Max unit length: No. bays x bay-width + 140mm front ramp + 30mm back edging

Bay depth (approx. shelf depth): Single - 300, 360, 400 & 440mm. Double - 600, 720, 800 & 880mm

Frame height: 1107, 1827, 2187mm

Unit height: Frame height + 85mm (base) + 38mm track/floor + up to 35mm floor adjustment

Shelf loading: 38kg

Max bay loading: 500kg

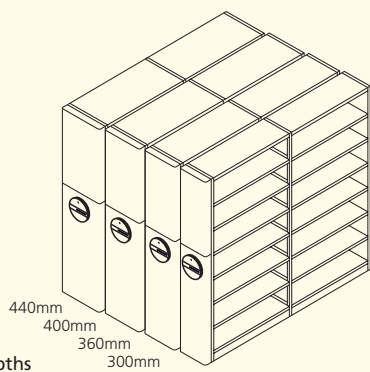
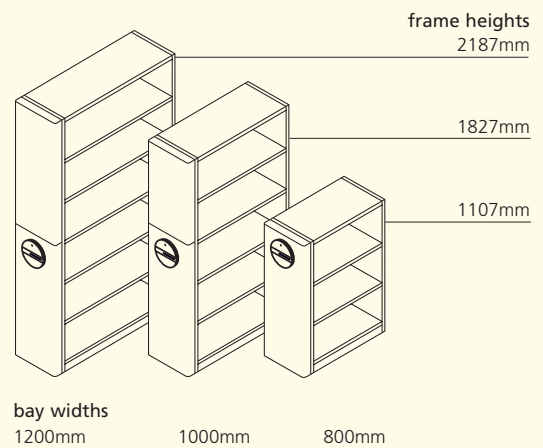

single depths

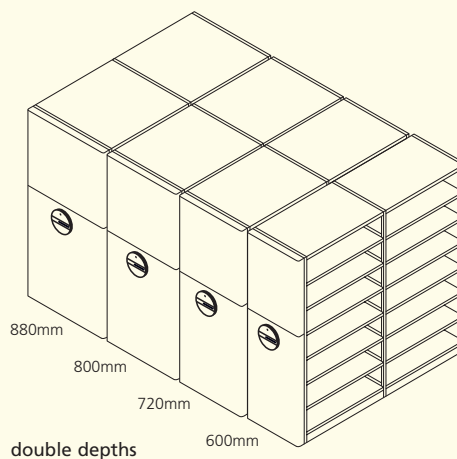

double depths

- increase storage capacity up to 100%
- create the same storage capacity in 50% less floor space
- release valuable space for other office use
- accommodates roll-out filing frames, media drawers and reference shelves



1. vertical media on 300mm shelf
2. horizontal media on dual purpose 360mm shelf
3. designed to SEMA & FEM code of practice
4. clean, quiet, ergonomic drive mechanism

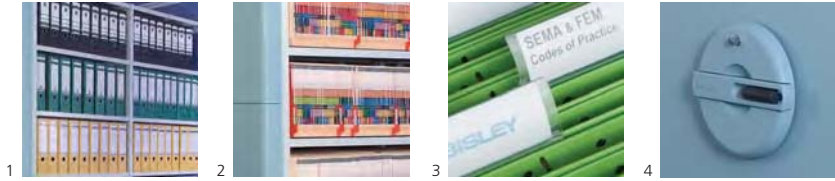

appendix: colour / standard dimensions

standard colour palette (smooth finish)

item	description	item	description
1.	graphite	9.	black
2.	goose grey	10.	oxford blue
3.	light grey	11.	coffee
4.	white	12.	light red orange
5.	edinburgh	13.	silver
6.	beige	14.	blue
7.	cream	15.	green
8.	pink	16.	yellow

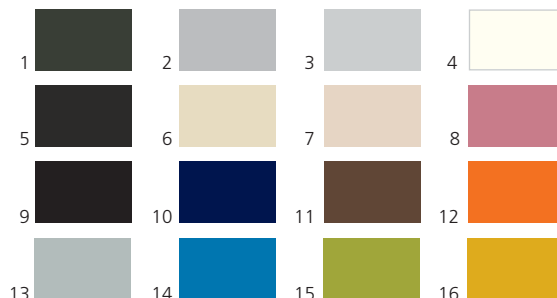

All cupboard internals are supplied in black, unless stated differently

Side opening tambour shutters available in: light grey (1), dark grey (9), black (5), cream (2) and silver (SL)

SystemFile tambour shutters available in: light grey (1), dark grey (9), black (5), cream (2), white (EW), beech (BC) and silver (SL)

A4 Eurotambour shutters available in: light grey (LG), dark grey (9), black (5), white (EW), cream (2), beech (BC) and silver (SL)

fast track colour palette (textured finish)

item	description
v4	goose grey
v5v6	coffee/cream duo



additional colour palette available for Bite, towers and InnerSpace (light-textured finish)

item	description	item	description
1.	n9 slate	11.	b7 derby
2.	g9 york	12.	a7 majolica
3.	b9 chalk	13.	n8 harley
4.	rn silver	14.	g8 regent
5.	n6 montana	15.	b8 portland
6.	g6 oregon	16.	a8 langham
7.	b6 alaska	17.	n5 saruk
8.	a6 florida	18.	g5 harvest
9.	n7 doulton	19.	b5 vanilla
10.	g7 minton	20.	a5 paprika

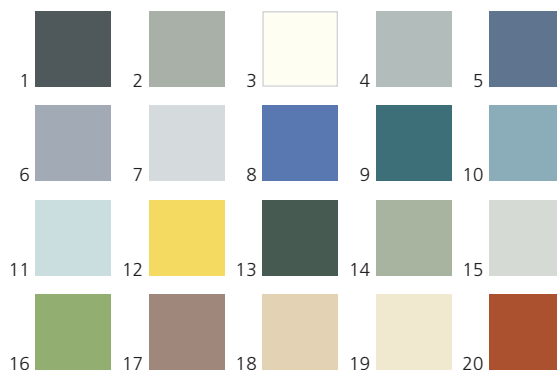

The colour blocks above are only approximations, please refer to Bisley metal colour samples for an exact representation.

standard dimensions



paper sizes

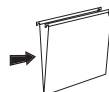

description	height mm	width mm	depth mm
A5	-	148	210
A4	-	210	297
foolscap	-	203	330
legal	-	216	356
american letter	-	216	280
A3	-	420	297

suspension files (A4)	235	-	320
suspension files (foolscap)	240	-	360

lateral files	275	-	330
---------------	-----	---	-----



description	height mm	width mm	depth mm
lever-arch files (A4)	313	75	280
lever-arch files (foolscap)	350	75	285

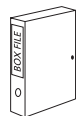

box files (A4)	337	75	265
box files (foolscap)	368	75	265



video	120	205	30
-------	-----	-----	----



cds	142	125	10
-----	-----	-----	----

The above dimensions are nominal and may differ between manufacturers

Guarantees & Service

All Bisley products are guaranteed to cover all defects in materials and workmanship. For details of specific guarantee periods against each product check for up to date information on our website www.bisley.com

Conditions

1. The guarantee is only valid with the customer's original invoice or proof of purchase (indicating the date of purchase, product type and dealer's name).
2. The guarantee does not cover damage resulting from misuse, neglect, or accidents and applies when the product is used during normal office hours. Where the product is used for periods which exceed normal office hours the guarantee is valid for eighteen months. (maximum 45 hours per week)
3. Failure due to fair wear and tear is specifically excluded.
4. This guarantee is not transferable and can only be exercised by the original purchaser and is only applicable to the UK Mainland.
5. Please arrange for the product to be returned to your Dealer for repair unless otherwise agreed.

The following notes for your (Dealer) guidance will be helpful:-

1. Please ensure your customer has proof of purchase, this will be required for in-guarantee repair.
2. If the furniture requires in-guarantee repair contact Bisley Customer Services and ask for a Service Request Form.
3. Should the furniture require repair out of guarantee contact Bisley Customer Services for a Repair Request Form.

Repair Service (dealer advice)

Bisley Office Furniture is able to offer a Repair Service for products requiring out of guarantee maintenance or repair. If you require the Repair Service please call Bisley Customer Services for a quotation.

Replacement Keys

To order replacement keys please contact:

Lowe and Fletcher - 0121 505 0400, with details of your product type, key series no. (available from Bisley Sales Office) purchase date and key/lock number.

Minimum Order value to dealer site

UK Mainland : £250

Northern Ireland and Scottish Highlands : £1500

Direct Delivery to end user site – UK mainland

FOC delivery for orders over £2500 in normal working hours (7am-5pm) Monday to Friday on 45 foot articulated vehicle.

Any requirements outside above times and vehicle size are subject to separate quotation – please contact Customer Service team to discuss your needs.

Order cancellation / delivery deferment

Any request to cancel an order placed to be made in writing. Cancellation costs will be advised based on following:

1. Product not scheduled for production: No charge
2. Standard product scheduled for assembly: quoted price less 50%
3. Special product scheduled for production and all product made awaiting despatch : quoted price

Any request to defer delivery from original request to be made in writing. Costs may be incurred and will be advised at time of enquiry.

London Showroom	Bisley Sarl	Bisley GmbH	Bisley BV	Bisley Ireland
Bisley Office Furniture	3 Bis Rue Julien Poupinet	Wiesenstrasse 70	Vollerstraat 2	
Northumberland House	78160 Le Chesnay	40549 Düsseldorf	5051 JV GOIRLE	
155-157 Great Portland St	France	Germany	Holland	
London, W1W 6QP, UK				
Tel: +44 (0)20 7436 7111	Tel: +33 (0)1 39 54 39 58	Tel: +49 211 87 541 600	Tel: +31 13 46 30 662	
Fax: +44 (0)20 7436 8111	Fax: +33 (0)1 39 55 98 03	Fax: +49 211 87 541 899	Fax: +31 13 46 39 615	Tel: +353 86 8048672
sales@bisley.com	c.kay@bisley.fr	info@bisley.de	info@bisley.nl	export@bisley.com

Head Office, Sales & Production

F C Brown (Steel Equipment) Ltd
Bisley Office Furniture
Queens Road
Bisley Surrey GU24 9BJ

Tel: +44 (0)1483 485 600
Fax: +44 (0)1483 489 962

www.bisley.com

Conditions of Sale

1. The ownership of the goods will only be transferred to the purchaser when the purchaser has paid all that is owing to F. C. Brown (Steel Equipment) Ltd in respect of all goods supplied. Where goods are lost, damaged or destroyed after delivery and ownership has yet to pass the purchaser will indemnify F. C. Brown (Steel Equipment) Ltd against any loss incurred provided such loss, damage or destruction does not result from the negligence of F. C. Brown (Steel Equipment) Ltd.
2. Payment Terms: Nett monthly.
3. All goods are invoiced at prices ruling at date of despatch.
4. This price list cancels and replaces all previous price lists.
5. We reserve the right to alter models and prices without prior notice.
6. We reserve the right to offset any amount that may be due to the purchaser against their sales ledger account with F.C. Brown (Steel Equipment) Ltd.

Bisley guarantee

The Bisley guarantee covers all defects in materials and workmanship; lengths of guarantee vary.

In accordance with our policy of continuous product development and improvement, we reserve the right to change the specifications of products illustrated and described in the brochure without prior notice.

Bisley is a registered trademark of
F.C. Brown (Steel Equipment) Ltd

www.bisley.com



URS CERTIFICATE NO.11599A/1



URS CERTIFICATE NO.11599/1

01-06-2009

Head Office, Sales & Production

F C Brown (Steel Equipment) Ltd
Bisley Office Furniture
Queens Road
Bisley Surrey
GU24 9BJ
Tel: +44 (0)1483 485 600
Fax: +44 (0)1483 489 962

Showroom

Bisley Office Furniture
Northumberland House
155-157 Great Portland Street
London
W1W 6QP
Tel: +44 (0)20 7436 7111
Fax: +44 (0)20 7436 8111

Design & Production

Bisley Office Furniture
Caswell Way
Reevesland Ind Est
Newport, Gwent
NP19 4PW
Tel: +44 (0)1633 637 383
Fax: +44 (0)1633 637 384