

# METAL FURNITURE

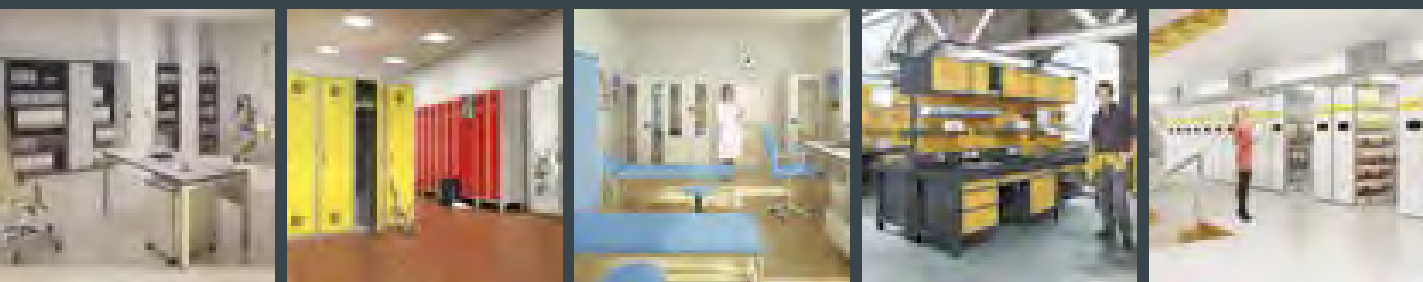

*Furniture you can depend on*





# WHO WE ARE

What we have begun 20 years ago, thanks to the creativeness and initiative of many people, resulted in the establishment of the company offering a very wide assortment of metal furniture. Our products reflect the commitment of the whole company, which as requested is ready to deliver each product of high quality guaranteed by MALOW brand mark.

Our company is based on people - people representing our customers, our suppliers, our business partners and our workers. We know perfectly well that our success would not be possible without the cooperation with our customers. Therefore, we carefully listen to your voice and we hope that we will fulfil your expectations.

I wish this catalogue will meet with positive reception and will be used effectively.

*Henryk Owsiejew*

*- experience:  
„we know everything  
about steel”*





# OUR MISSION

Our mission is to achieve the position of strategic partner for customers and environment of business:

- by complex offer and the highest quality services,
- by development possibilities for employees,
- by providing benefits for copartners.



# HISTORY

The Malow Brand has been known since 1997, however the history of the company is much longer.

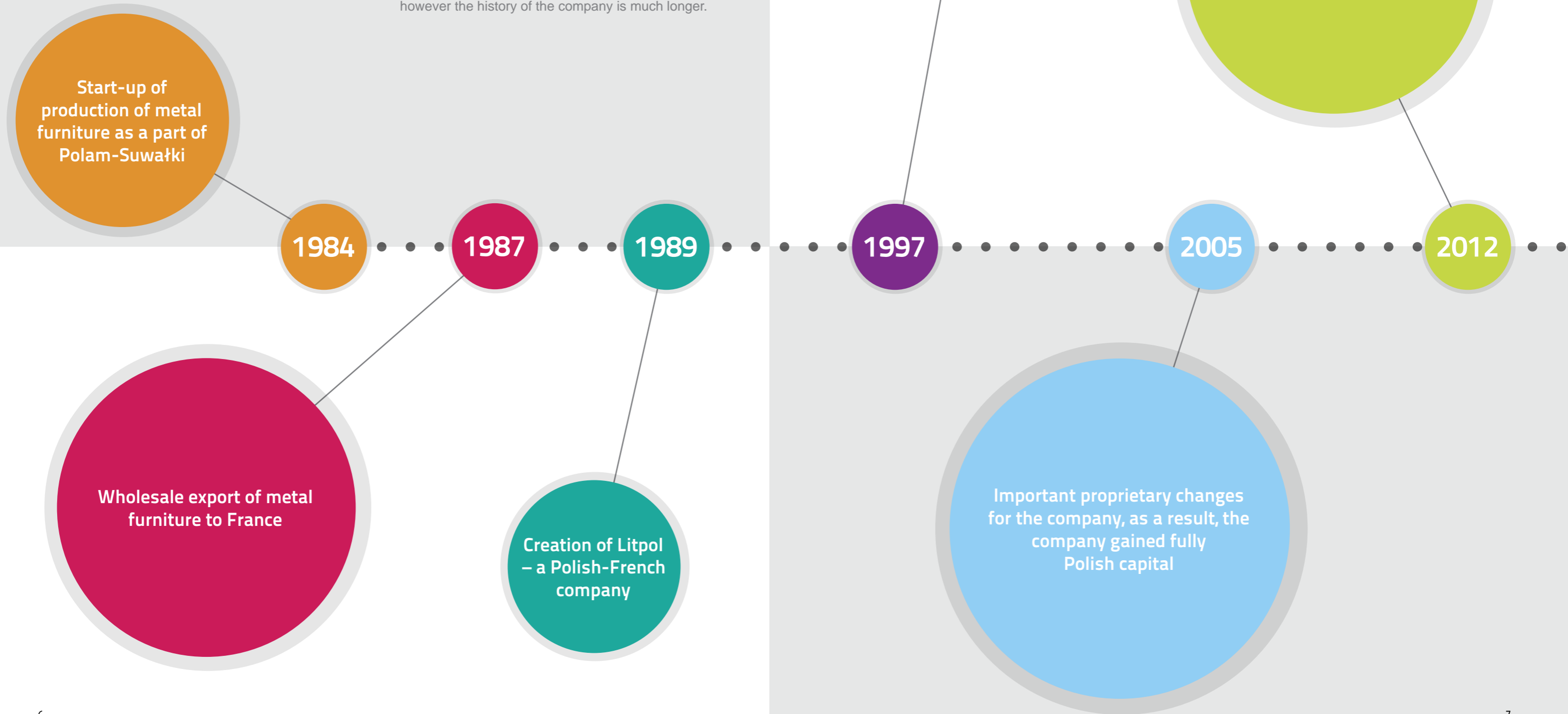





# VALUES

Our greatest asset is confidence our customers put in us, as well as stable and experienced staff. Our successes are the motor of our activities and they encourage us to improve and to fulfil new needs of our customers.

Malow company as it's key values recognises:

1. Customer
2. Employees
3. Development
4. Responsibility
5. Lucidity
6. Confidence
7. Honesty
8. Effective Communication



# CORPORATE SOCIAL RESPONSIBILITY

Social responsibility is an element of our long-term strategy. It is based on the principles of social dialogue and search for solutions advantageous for our environment:

- employees,
- business partners,
- contractors,
- natural environment,
- local society, where we live and work.

From the beginning Malow company engages into social initiatives of different kinds. We recognize charity as an important aspect of corporate social responsibility.

- we help non-governmental organizations with articles and finances.

- we fund summer and winter holiday actions for children from poor or dysfunctional families.
- we financially assist centres that conduct feeding homeless and poor people, we back up local fund-raisers for helping sick person.
- for many years we have been supporting local schools and educational institutions by handing over the equipment and funding organised campaigns, e.g. promoting innovative ideas of young people.
- we joined the DKMS foundation campaign „Together against leukaemia” by organising the day of the bone marrow donor in the company.





# ENVIROMENT PROTECTION

Bearing in mind natural values of the Sudovia, Malow has consciously been taking actions in the sphere of the organization and the environmental management. Thinking about future generations, these actions are directed towards the respect of natural environment. Our efforts concerning natural environment are coordinated as part of the environmental management system in accordance with the requirements included in the ISO 14001 norm. We treat the environmental management as one of priorities in managing the company. We are also systematically carrying out inspections and evaluations of environmental aspects. Parameters of significant environmental aspects will be constantly improved by setting appropriate environmental goals.

As part of the improvement in the environmental impact we are aiming at:

- proecological management of industrial waste by proper segregation, repeat exploiting or recycling it,
- planning and realization of operations preventing potentially ecologic hazards from appearing,
- raising the awareness of our employees about the environmental impact made by their work.





# SPONSORSHIP

As part of funding for sport, we have been sponsoring Suwalki Badminton Club – SKB „LITPOLMALOW”. SKB „LITPOL-MALOW” is the most professional and the best organized badminton club in Poland. This is represented not only in the collective, but also individual players’ successes. Our players have taken part in the Olympic Games in Atlanta, Sydney, Athens and Beijing. They have repeatedly been winning European and World competitions. Also, they have taken part in international tournaments in Switzerland, the World Grand Prix in Brunei, Singapore, Germany Open, Holland Open.



We also aid Wigry Suwalki football club - the most popular sport team in our town. In its rich, over sixty-year history it has raised many great football players, including Poland’s national team representatives (Patryk Małecki, Wojciech Kowalewski).



**NASI MISTRZOWIE  
NA OLIMPIADZIE  
LONDYN 2012**

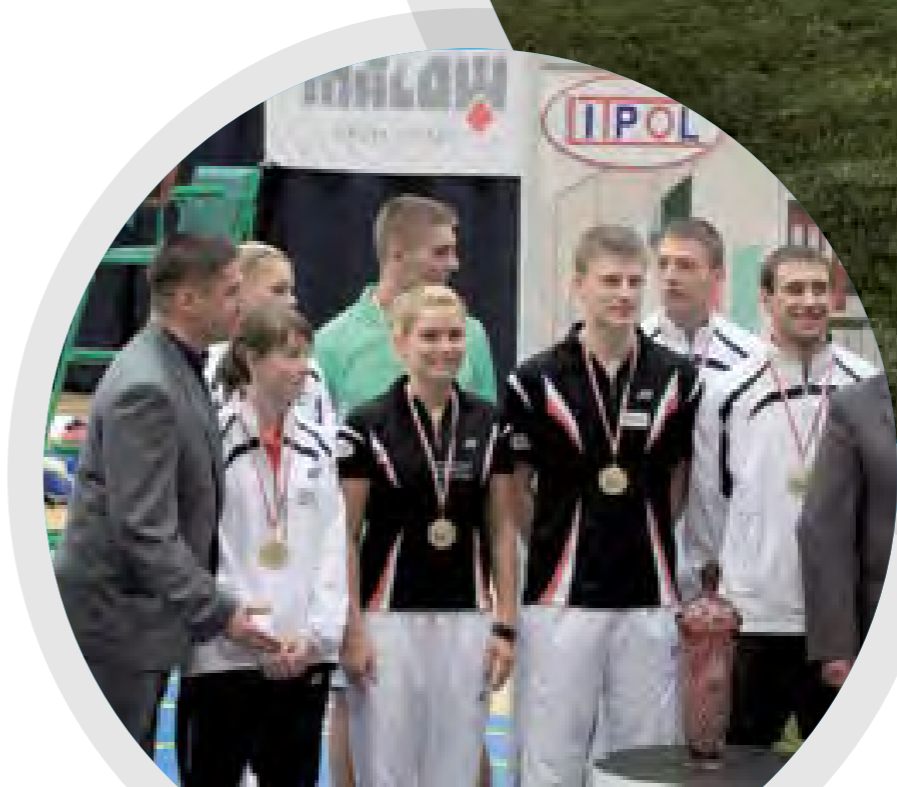



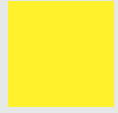

# QUALITY AND SERVICES

Starting from 1989, the range of our metal furniture is a synonym of reliability, creativeness and functionality. Our motto is: "Furniture you can depend on"

The primary aim of Malow Company is to satisfy our customers fully as a result of good quality metal furniture, safes and of our services.

Certificates and seals of approvals we have been given prove our constant care of high quality of our products.

Malow's certificates:

- certificate of the quality management system in accordance with ISO 9001,
- certificate of the environmental management system in accordance with ISO 14001,
- hygienic approvals,
- qualification approval of reaction to fire,
- certificates of conformity with Polish norms,
- NATO Commercial and Government Entity (NCAE) Code.





# TECHNOLOGY, MACHINERY RESOURCES

/Kaizen - 改善 /improvement/a change for better/

For over 15 years we have been working in accordance with Japanese managing practices called Kaizen – never-ending process of improvement. The essential rule of this philosophy is constant involvement of the entire organization and willingness to continual refinement of the company and product.

Thanks to continuous investments in the production technology Malow belongs to the most innovative companies in the country. Modern and universal machines for processing and forming metal sheets as well as metal profiles, new technologies of powder coating, as well as constant supervision of our own technical staff - that ensure the best quality of our furniture.

In order to increase the productivity and the quality of our products we are constantly developing our machinery stock.

We are working on machines of renowned companies such as Salvagnini, Amada or Safan.

Our machinery resources includes:

- fibre-optic lasers,
- P4 bending centres,
- guillotine shears,
- stationery and pincer welding machines,
- band sawing machines,
- angle bending machines and edge presses,
- numerically controlled revolver fine cutters,
- eccentric presses of the pressure of up to 100 tons.

In 2013 we have launched the most modern in Europe automatic line for production of metal wardrobes. The line consists of 13 production stations and automatiz-

es processes such as: storing, transport of elements between operations, cutting, bending, and welding performed by robots. The automatic production line assures high quality of our wardrobes what is proved by:

- precision - all elements are being carried out with the precision of up to 0.25 mm,
- automatic bending of closed profiles,
- synchronous work of 2 robots on one element.

In 2013 we have purchased another laser system - the newest L3 Salvagnini system equipped with automatic inoculants of palettes and new P4 Salvagnini bending centre with the system of giving and receipt of details.

The process of powder coating takes place on automatic line which is the biggest in the country in terms of painting guns installed and the best quality powder from the biggest world producers is used in the process.

As we are aware of the quality of our products we are granting extended statutory warranty! Period of entitlements on account of the statutory warranty for physical defects of goods amounts to 24 months from the day of sale.

In order to assure durability of our movable shelving systems we grant the statutory warranty for 24 months!



# AWARDS

The actions of the company are appreciated by our customers and the market. MALOW was given many awards:

- 4 Diamonds to "the Golden Statuette of Polish Business Leader" awarded by Business Centre Club,
- the title "Ambassador of the Polish Economy" in the category "Foreign Business Partner",
- "Firma Dobrze Widziana" ("Positively Received Company"),
- FORBES Diamonds,
- "Pillars of Polish Economy",
- the title "Superfirma" ("Supercompany"),
- "Business Gazelle",
- "Pearl of Polish Economy",
- European medals for: offer of metal furniture, movable shelving system, laptop trolley,
- "Leader of Polish Business",
- "Rzetelna Firma" ("Honest Company").



Laureate of the Golden Statuette of Polish Business Leader



# DISTRIBUTION NETWORK

/DISTRIBUTION/LOGISTICS/BRANDS/

Our offer, due to its complexity, allows for equipping offices, banks, cloakrooms, studies, archives of many workplaces, companies and offices, schools and libraries, hospitals and doctor's offices, workshops and others.

In other words, we are with our products everywhere where there are documents, clothes, tools, which means EVERYWHERE.

The company's products reach recipients via network of 70 dealers on the area of the entire Poland, and 25 outside the country. Moreover, products of Malow com-

pany are increasingly reaching customers through B2B channels. Approximately half of our sales find customers in Poland, and the other half is designed for export.

The company is known in all European Union countries, especially in France, Germany and Scandinavia.





# FACTS AND NUMBERS

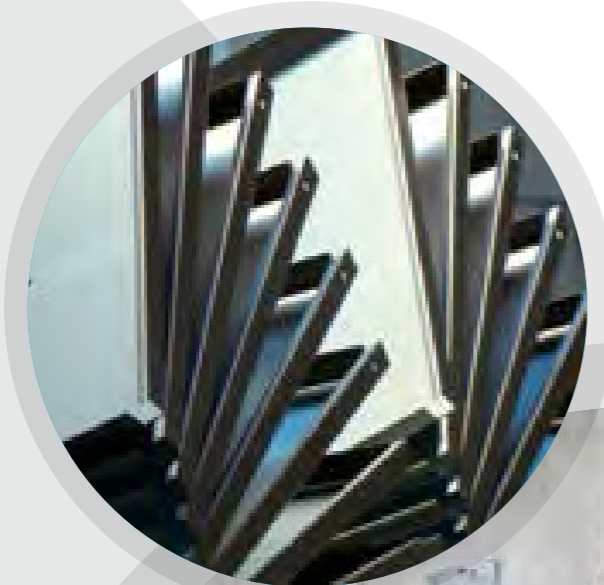

Scope of business: manufacture of metal furniture  
 Location: North-East Poland: Suwałki  
 Activity since: 1989  
 The number of people employed: approx. 500  
 Production sites: Suwałki (Poland)  
 Kharkov (Ukraine)  
 Distribution: around the world  
 Export: over 50% of production  
 Manufacturing capacity: 280 000 pieces of furniture per year  
 Scope of material processing: 1 200 tons of metal sheet per month  
 ca. 400 tons of powder per year  
 Number of orders: ca. 37 750 per year (2006 - 2012)

Motto: *Furniture  
 you can depend on*

Our strong points:

- the quality,
- rich offer,
- professional, full service,
- experienced technical staff,
- advanced technology park,
- rich colours,
- certificates,
- diversity,
- flexibility - special products.



GPS Coordinates  
 +54° 3' 17.79", +22° 55' 54.06"  
 (54.054942, 22.931682)

# METAL FURNITURE

## CONTENTS

---

	Office furniture	28	
	Social furniture	80	
	Medical furniture	142	
	Workshop furniture	162	
	Movable shelving systems	186	

- experience:  
„we know everything  
about steel“



# OFFICE FURNITURE

*Furniture  
you can depend on*



# OFFICE FURNITURE

## CONTENTS

Cabinets with wing doors	32
Cabinets with retractable doors	38
Cabinets with shutter doors	40
Cabinets with sliding doors	44
Open racks	46
Additional equipment	48
SKB Cabinets for documents and files	52
SAM W Reinforced cabinets for documents	54
SZK 301 OG Filing cabinets with increased fire resistance	54
SZK Filing cabinets	56
SCD Cabinets for CD's	62
SRM Drawing cabinets	64
Classroom furnishing E-class	66
SKT Cabinets for catalogues	68
RMB Library racks	70
Office desks	72
Desk connectors	74
Mobile pedestals	76
Table tops	78

Metal office furniture allows for modern, functional and practical equipment of a workplace. Metal optimally meets the requirements in terms of design, quality, functionality and durability. Comfort, functionality, ergonomics – these are the features of metal office furniture which customers appreciate most. In the case of individual needs we are able to offer a wide range of solutions prepared according to your expectations.

Our offer includes:

- Filing cabinets with wing, shutter, retractable, sliding doors,
- Reinforced cabinets for documents,
- Filing cabinets,
- Drawing cabinets,
- Library racks,
- Desks,
- Tables.

There are also versions of a wardrobe – filing locker, with a compartment, closed cabinets.

**Cabinet with a combination of wardrobe and filing** – SBM 206, SBM 215 – is equipped with a wardrobe section with a bar and hooks for clothes, as well as four shelves for documents: 1 long shelf with a pull-out hanger and 3 adjustable short shelves every 25 mm ± 3 positions from the center position, fixed to the partition wall placed in the middle of the cabinet.

**Cabinet with compartment** – SBM 204, 213, two-door compartment with a partition, welded, lockable with single-point cylinder lock and 3 shelves every 25mm, ± 3 positions from the center position.

	Hanging file sizes		For self-assembly		Non-combustible
	Sizes		Adjustable shelves		30 kg drawer load capacity
	The drawer on full extension ball bearing slides		Shelves adjustable in increments		40 kg drawer load capacity
	Stackable		Possibility of mounting to a wall		50 kg drawer load capacity
	Anti-tilt system		On wheels		Possibility of removing drawers
	Binder		Shelves adjusted to hanging files		Elements for leveling
	Center lock		25 kg shelf load capacity		180° door swing angle
	CD-ROM		40 kg shelf load capacity		110° door swing angle
	Adjustable feet height		60 kg shelf load capacity		
	Possibility of hanging clothes		80 kg shelf load capacity		



# OFFICE FURNITURE

## SBM OFFICE CABINETS WITH WING DOORS



door handle with locking in 2 points

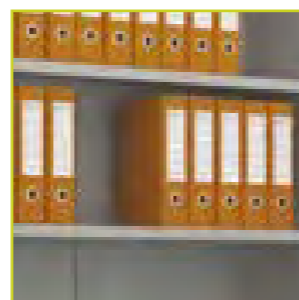

adjustable shelves

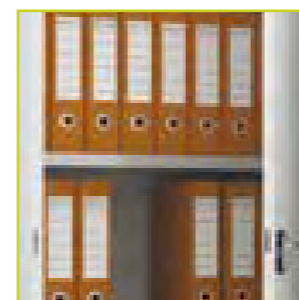

maximum load capacity – 60 kg (optional 80 kg)

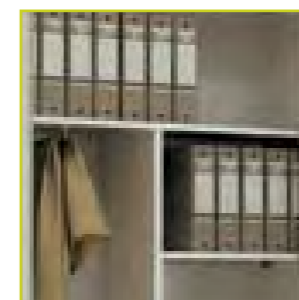

version of wardrobe-filing cabinet available

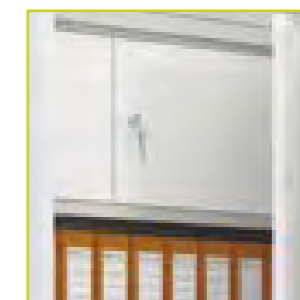

version with compartment available



top lockers available

Filing cabinets with wing doors are the most popular and frequently chosen among our offer of office furniture. In addition, their price competitiveness brings about their leading position on the top-list products.

Office cabinets are of comprehensive use thanks to varied possibilities of their inside equipment: shelves adjustable every 25mm, extended shelves, full drawers, frame drawers.

The standard cabinets equipped with adjustable shelves every 25 mm:

- **small cabinets – Sbm 101, 102, 103, 107** - 2 adjustable shelves every 25mm ± 4 positions from the center position,
- **high cabinets – Sbm 201, 202, 203, 212** – 4 adjustable shelves every 25mm ± 3 positions from the center position.

Standard shelf load capacity – 60 kg.

Optional shelf load capacity – 80 kg.

### STANDARD EQUIPMENT:

- door handle with locking in 2 points (top and bottom of the door),
- adjustable shelves,
- maximum load capacity – 60 kg (optional 80 kg),
- version of wardrobe-filing cabinet available,
- version with compartment available,
- top lockers available.



# OFFICE FURNITURE

## SBM OFFICE CABINETS WITH WING DOORS

The doors with hidden hinges. Door handle with security lock. Locking in 2 points (top and bottom).

### ADVANTAGES OF THE CABINETS:

- extensive equipment as standard,
- 16 colours RAL at no extra cost,
- different dimensions and elements of equipment,
- adjustable shelves,
- various versions of cabinets,
- various versions of the price.



### ADVANTAGES OF THE CABINETS



extensive equipment  
as standard



16 colours RAL  
at no extra cost

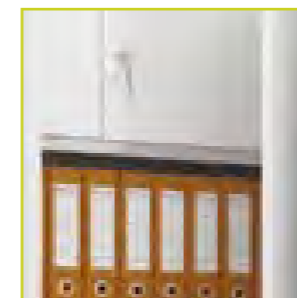

different dimensions and  
elements of equipment

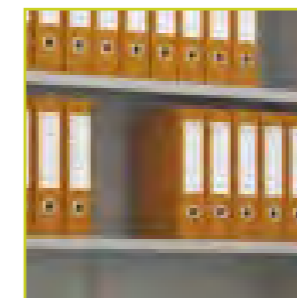

adjustable shelves



various versions  
of cabinets



various versions  
of the price



# OFFICE FURNITURE

## SBM OFFICE CABINETS WITH WING DOORS

We offer a wide range of top cabinets. The width of small cabinets is adjusted to the width of standard cabinets. Available top cabinets:  
 - a height of 465 mm – for 2 low rows of documents,  
 - a height of 810 mm – for 2 rows of binders.  
 Extensions cabinets have one adjustable shelf every 25 mm ± 3 positions from the center position.

Designation	SBM 101 M	SBM 102 M	SBM 103 M	SBM 107 M	SBM 201 M	SBM 202 M	SBM 203 M	SBM 212 M
Code	SBM 01022203	SBM 02022303	SBM 03022303	SBM 04022303	SBM 01032204	SBM 02032304	SBM 03032304	SBM 04032304
Height (mm)	1040		1040		1990			
Width (mm)	600	800	1000	1200	600	800	1000	1200
Depth (mm)	435		435		435			
Cabinet's capacity	2 rows of binders		2 rows of binders		5 rows of binders			
Number of shelves	2		2		4			

Designation	SBM 204 M	SBM 213 M	SBM 206 M	SBM 215 M
Code	SBM 03032305	SBM 04032305	SBM 03032306	SBM 04032306
Height (mm)	1990		1990	
Width (mm)	1000	1200	1000	1200
Depth (mm)	435		435	
Cabinet's capacity	4 rows of binders + locker		1 row of binders + 4 in halves	
Number of shelves	3		4 shelves + wardrobe compartment	

Cabinets have the possibility of applying levelling feet attached to the bottom with screws at an extra cost. They are regulated from the inside of the cabinet.

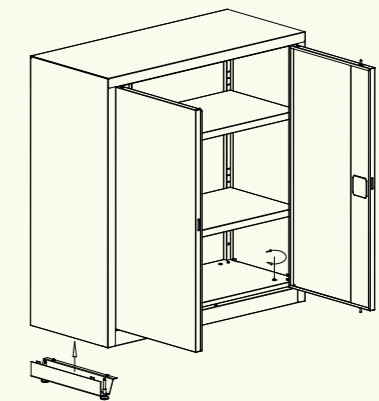

Designation	SBM 401 M	SBM 402 M	SBM 403 M	SBM 405 M	SBM 801 M	SBM 802 M	SBM 803 M	SBM 804 M
Code	SBM 01012202	SBM 02012302	SBM 03012302	SBM 04012302	SBM 01122202	SBM 02122302	SBM 03122302	SBM 04122302
Height (mm)	465		465		810			
Width (mm)	600	800	1000	1200	600	800	1000	1200
Depth (mm)	435		435		435			
Cabinet's capacity	2 low rows		2 low rows		2 rows of binders			
Number of shelves	1		1		1			

# OFFICE FURNITURE

## SBM OFFICE CABINETS WITH RETRACTABLE DOORS

The office cabinet with retractable doors significantly reduces the space needed to open the cabinet. The doors slide into sides of the cabinet.

### STANDARD EQUIPMENT:

**Sbm 210** - standard equipment: 4 adjustable shelves (every 25 mm ± 3 positions from the center position),  
**Sbm 211** - the two-door storage compartment, welded, lockable with single-point cylinder lock bolt, 3 adjustable positions of shelves.

### ADDITIONAL EQUIPMENT:

Extended shelf, full drawer, frame drawer.

Maximum load capacity of shelf, frame drawer, full drawer and framer drawer in cabinets with retractable doors is 40 kg.

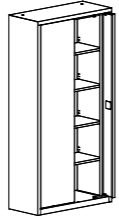
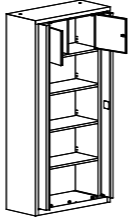

## TECHNICAL SPECIFICATION

		
Designation	SBM 210 M	SBM 211 M
Code	SBMC 03032804	SBMC 03032805
Height (mm)	1990	
Width (mm)	1000	
Depth (mm)	435	
Cabinet's capacity	5 rows of binders	4 rows of binders + locker
Number of shelves	4	3



# OFFICE FURNITURE

## SBM OFFICE CABINETS WITH SHUTTER DOORS

Office cabinets thanks to its elegant, silent and lightly opening and closing shutter doors are very popular in offices. Their functionality and a wide range of additional accessories provide high flexibility in interior design. Shutter doors are made from plastic slats, with the lock latch with 2 keys. Maximum standard shelf load capacity - 40 kg.

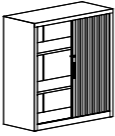
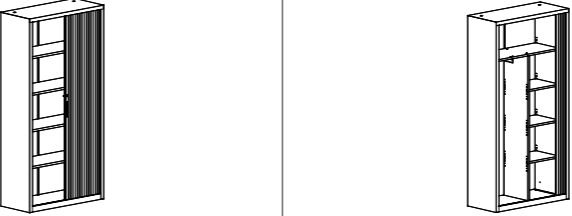
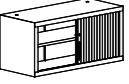

### TECHNICAL SPECIFICATION

								
Designation	SBM 105 M	SBM 109 M	SBM 208 M	SBM 217 M	SBM 218 M	SBM 219 M	top mounted cabinet SBM 404 M	top mounted cabinet SBM 406 M
Code	SBMZ 03021703	SBMZ 04021703	SBMZ 03031704	SBMZ 04031704	SBMZ 03031706	SBMZ 04031706	SBMZ 03011702	SBMZ 04011702
Height (mm)	1040		1990				465	
Width (mm)	1000	1200	1000	1200	1000	1200	1000	1200
Depth (mm)	435		435					
Cabinet's capacity	2 rows of binders		5 rows of binders		1 row of binders + 4 in halves		2 low rows	
Number of shelves	2		4		4 shelves + wardrobe compartment		1	



# OFFICE FURNITURE

## SBM OFFICE CABINETS WITH SHUTTER DOORS

- The cabinet has shelves adjustable every 25 mm:
- **Sbm 208, 217, 218, 219:** 4 shelves adjustable  $\pm 3$  positions from the center position,
  - **Sbm 105, 109:** 2 shelves adjustable  $\pm 4$  positions from the center position,
  - **Sbm 701:** 2 shelves adjustable  $\pm 3$  positions from the center position,
  - **Sbm 404, 406:** 1 shelf  $\pm 3$  positions from the center position.

Maximum load capacity per shelf, extended shelf, drawer and frame drawer in cabinets with shutter doors is 40 kg.

### STANDARD

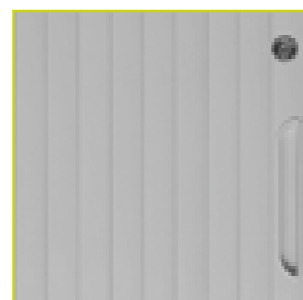

Grey

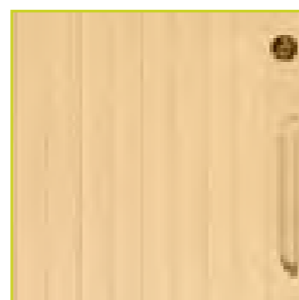

Cream



Black

### AT AN EXTRA COST



White



Silver



Beech





# OFFICE FURNITURE

## SBM OFFICE CABINETS WITH SLIDING DOORS

Office cabinets with sliding doors do not require any additional office space while opening them, and their aesthetic value and reliability is appreciated by the users.



Szafy **Sbm 222, 220, 221** - have 4 shelves adjustable every 25 mm.

Szafy **Sbm 112, 110, 111** – have 2 shelves adjustable every 25 mm.

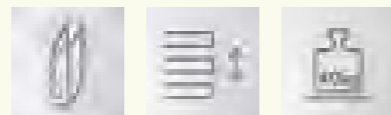
Cabinets are equipped with a cylindrical lock and door handle.

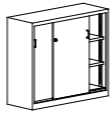
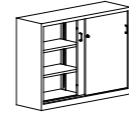

### TECHNICAL SPECIFICATION

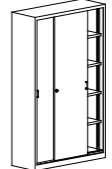
						
Designation	SBM 112	SBM 110	SBM 111	SBM 222	SBM 220	SBM 221
Code	SBMP 03020803	SBMP 4020803	SBMP 05020804	SBMP 03030804	SBMP 04030804	SBMP 05030820
Height (mm)	1040		1040	1990		
Width (mm)	1000	1200	1400	1000	1200	1400
Depth (mm)	435		435			
Cabinet's capacity	2 rows of binders		2 rows of binders	5 rows of binders		
Number of shelves	2		4 – 2 shelves on each side of the partition wall	4	8 – 4 shelves on each side of the partition wall	

# OFFICE FURNITURE

## RZ CABINETS WITHOUT DOORS





Cabinets without doors are very practical and popular in various kinds of offices. They combine the strength of metal office cabinets and allow for easy access to the stored documents.

Racks equipped with shelves:

- small racks – RZ 101, 102, 103, 107 - 2 adjustable shelves 25 mm ± 4 positions from the centre position,
- high racks – RZ 201, 202, 203, 212 - 4 shelves adjustable every 25 mm ± 3 positions from the centre position.

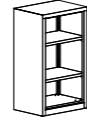
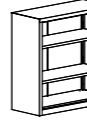
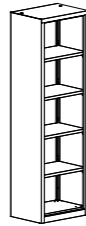

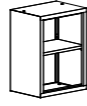
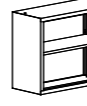
### TECHNICAL SPECIFICATION

								
Designation	RZ 101 lx	RZ 102 lx	RZ 103 lx	RZ 107 lx	RZ 201 lx	RZ 202 lx	RZ 203 lx	RZ 212 lx
Code	SBM 01022903	SBM 02022903	SBM 03022903	SBM 04022903	SBM 01032904	SBM 02032904	SBM 03032904	SBM 04032904
Height (mm)	1040		1040		1040		1990	
Width (mm)	600	800	100	1200	600	800	1000	1200
Depth (mm)	435		435		435		435	
Cabinet's capacity	2 rows of binders		2 rows of binders		2 rows of binders		5 rows of binders	
Number of shelves	2		2		2		4	
<b>Top cabinets</b>								
Designation	RZ 801 lx	RZ 802 lx	RZ 803 lx	RZ 804 lx	RZ 401 lx	RZ 402 lx	RZ 403 lx	RZ 405 lx
Code	SBM 01122902	SBM 02122902	SBM 03122902	SBM 04122902	SBM 01012902	SBM 02012902	SBM 03012902	SBM 04012902
Height (mm)	810		810		810		465	
Width (mm)	600	800	1000	1200	600	800	1000	1200
Depth (mm)	435		435		435		435	
Cabinet's capacity	2 rows of binders		2 rows of binders		2 rows of binders		2 low rows	
Number of shelves	1		1		1		1	

# OFFICE FURNITURE

## ADDITIONAL EQUIPMENT

## ADDITIONAL EQUIPMENT



shelf



extendable shelf



extendable drawer



extendable frame drawer for hanging files



levelling feet



## TECHNICAL SPECIFICATION

For office cabinets we often need some additional equipment:

- **additional shelf** - adjustable every 25 mm ± 3 positions ( ± 4 positions in small cabinets - Sbm 101, 102, 103, 107),
- **Extendable shelf, framer drawer, full drawer** - Adjustable every 25 mm ± 2 positions from the centre, mounted on ball bearing of full extension.

Maximum load capacity of standard shelves:

- for cabinet with wing doors - 60 kg, 80 kg (optional)
- Cabinet with retractable doors and shutter doors - 40 kg.

There are also additional tops for office cabinets (choices of tops on p. 79)

Shelf	Shelf 60 kg		Shelf 60 kg		Shelf 80 kg			
	XSBM 18600101	XSBM 18640101	XSBM 18680101	XSBM 18720101	XSBM 22600901	XSBM 22640901	XSBM 22680901	XSBM 22720901
Designation	Shelf 60 kg		Shelf 60 kg		Shelf 80 kg			
Code	XSBM 18600101	XSBM 18640101	XSBM 18680101	XSBM 18720101	XSBM 22600901	XSBM 22640901	XSBM 22680901	XSBM 22720901
Height (mm)	28		28		23			
Width (mm)	594	794	994	1194	594	794	994	1194
Depth (mm)	385		385					
Applicable to	SBM 101 M	SBM 102 M	SBM 103 M	SBM 107 M	SBM 101 M	SBM 102 M	SBM 103 M	SBM 107 M

Shelf for cabinets with retractable and shutter doors	Shelf		Shelf
	XSBMZ 11200601	XSBMZ 11210601	XSBMZ 11190601
Designation	Shelf		Shelf
Code	XSBMZ 11200601	XSBMZ 11210601	XSBMZ 11190601
Height (mm)	23		23
Width (mm)	847	1047	647
Depth (mm)	385		385
Applicable to	SBM 105 M /208 M/210 M	SBM 109 M	SBM 701





# OFFICE FURNITURE

## ADDITIONAL EQUIPMENT

For office cabinets we often need some additional equipment:

- **additional shelf** - adjustable every 25 mm ± 3 positions, ± 4 positions in small cabinets - Sbm 101, 102, 103, 107,
- **Extendable shelf, framer drawer, full drawer**, - Adjustable every 25 mm ± 2 positions, mounted on full extension ball bearing slides.

The proposed elements allow to adjust each cabinet to the individual customers' needs.

Extendable shelf							
	for cabinets with winged doors		for cabinets with winged doors		for cabinets with retractable/shutter doors		
	Code	XSBM 19761701    XSBM 19801701	XSBM 19841701    XSBM 19881701	XSBMZ 12320701    XSBMZ 12330701			
	Height (mm)	52		52			
	Width (mm)	424    624	824    1024	771    971			
	Depth (mm)	370		370		357	
	Applicable to	SBM 101 M    SBM 102 M	SBM 103 M    SBM 107 M	SBM 105 M/208 M/ 210 M    SBM 109 M			



Frame drawer							
	for cabinets with winged doors		for cabinets with winged doors		for cabinets with retractable/shutter doors		
	Code	XSBM 21920301    XSBM 21960301	XSBM 21A10301    XSBM 21A50301	XSBMZ 14560301    XSBMZ 14570301			
	Height (mm)	95		95			
	Width (mm)	424    624	824    1024	751    951			
	Depth (mm)	358		358		360	
	Applicable to	SBM 101 M    SBM 102 M	SBM 103 M    SBM 107 M	SBM 105 M/208 M/210 M    SBM 109 M			



Shelf							
	for cabinets with winged doors		for cabinets with winged doors		for cabinets with retractable/shutter doors		
	Code	XSBM 20761801    XSBM 20801801	XSBM 20841801    XSBM 20881801	XSBMZ 13440801    XSBMZ 13450801			
	Height (mm)	102		102			
	Width (mm)	424    624	824    1024	771    971			
	Depth (mm)	370		370		370	
	Applicable to	SBM 101 M    SBM 102 M	SBM 103 M    SBM 107 M	SBM 105 M/ 208 M/ 210 M    SBM 109 M			

# OFFICE FURNITURE

## SKB CABINETS FOR DOCUMENTS AND FILES

Cabinets for documents and files are a perfect and a practical combination of the filing cabinet for files with the cabinet for other documents.

Drawers are installed on double extension ball bearing slides, protected from falling out.

Cabinets have a special mechanism allowing for opening of only one of the drawers at a time which protects the cabinet against tipping.

Drawers are equipped with a central locking mechanism. Maximum load capacity of each drawer is approx. 40 kg. The cabinet is made of powder coated steel sheet and the bottom part of the cabinet is made of zinc galvanized steel sheet.

Door handle is equipped with lock securing cabinet in 2 points.

In the part for documents there are adjustable shelves every 25 mm.

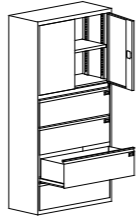
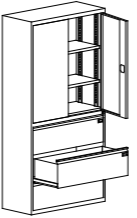
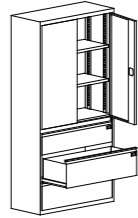

### TECHNICAL SPECIFICATION

			
Designation	Skb 1	Skb 2	Skb 3
Code	SKB 01010201	SKB 01010202	SKB 01010203
Height (mm)	1990	1990	
Width (mm)	1000	1000	100
Depth (mm)	435	435	
Capacity of drawers	4 drawers for hanging files, A4 size, hanging horizontally	3 drawers for hanging files, A4 size, hanging horizontally	2 drawers for hanging files, A4 size, hanging horizontally
Number of shelves	1 shelf – for two rows of binders	2 shelves – for two rows of binders + 1 low shelf	2 shelves – for 3 rows of binders



# OFFICE FURNITURE

## SAM W REINFORCED CABINETS FOR DOCUMENTS FILING CABINETS WITH INCREASED FIRE RESISTANCE

### SAM W REINFORCED CABINETS FOR DOCUMENTS

This cabinet is filled with fireproof mineral wool – ideal for keeping important documents. The cabinet has filling protecting against fire. Doors are bolted – secured with certified lock in class A.

For Sam W lockers we offer - as an option:

- compartment,
- extendable shelves,
- frame drawers.

There is also a possibility of fixing the cabinet to the floor and installing a combination lock.

### FILING CABINETS WITH INCREASED FIRE RESISTANCE

Double sheet steel cabinet. The space between cabinet sheaths is filled with a fireproof material. Fire resistant filling significantly extends the time of fire access to the documents. Fireproof seal protects the cabinet contents against quick warming. There is the possibility of storing A4, Folio, Grand Folio formats.

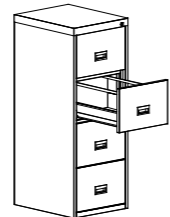

## TECHNICAL SPECIFICATION

	
Designation	Szk 301og
Code	SZKW 01030301
Height (mm)	1380
Width (mm)	530
Depth (mm)	635
Number of shelves	4
Number of rows per drawer	1
Internal dimensions of drawers (mm)	H x W x D: 240 (front 318 mm) x 385 x 540
Maximal size of files (mm)	265 x 383

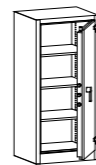
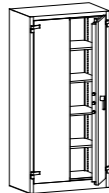
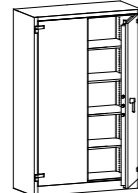
			
Designation	Sam W 1a	Sam W 2a	Sam W 3a
Code	SAMW 01010102	SAMW 02020203	SAMW 03020203
Height (mm)	1500	1950	1950
Width (mm)	700	950	1260
Depth (mm)	550		550
Cabinet's capacity	4 rows of binders	5 rows of binders	5 rows of binders
Number of shelves	3	4	4

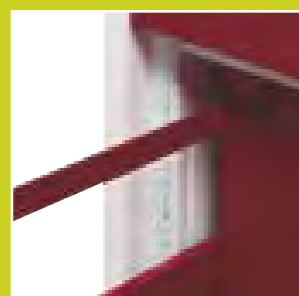



# OFFICE FURNITURE

## SZK FILING CABINETS

Filing cabinets are made of steel sheet with a base made of zinc galvanized steel sheet. Drawers are installed on double extension ball bearing slides, protected against falling out. Cabinets have a special mechanism allowing for opening of only one of the drawers at a time which protects the cabinet against tipping. Drawers are equipped with a central locking mechanism. Maximum load capacity of each drawer is approx. 50 kg. There are self-adhesive cardholders available in relation to the number of drawers. Cabinets are equipped with the shims for levelling. Cabinets available in various price versions.



### TECHNICAL SPECIFICATION



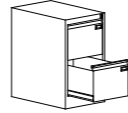
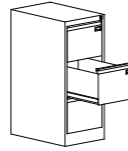
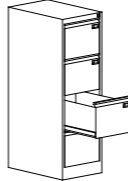
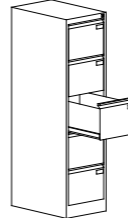
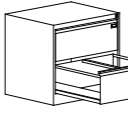
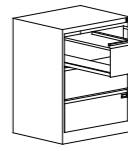
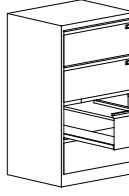

							
Designation	Szk 101	Szk 201	Szk 301	Szk 301/5	Szk 102	Szk 202	Szk 302
Code	SZK 01010101	SZK 01020201	SZK 01030301	SZK 01140401	SZK 02010801	SZK 02020901	SZK 02031001
Height (mm)	715	1000	1285	1568	715	1000	1285
Width (mm)	415		415		775		
Depth (mm)	630		630		630		
Number of shelves	2	3	4	5	2	3	4
Number of rows per drawer	1		1		2		
Internal dimensions of drawers (mm)	H x W x D: 244 (front 280 mm) x 330 x 585		H x W x D: 244 (front 280 mm) x 330 x 585		H x W x D: 244 (front 280 mm) x 690 x 585		
Size	A4		A4		A4		

# OFFICE FURNITURE

## FILING CABINETS

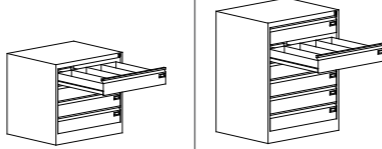
Additional equipment – available at an extra cost:  
 - supports for drawers,  
 - top plate (selection of plates on page 79).

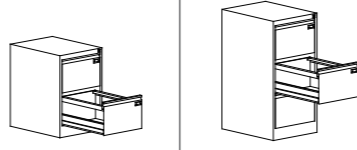
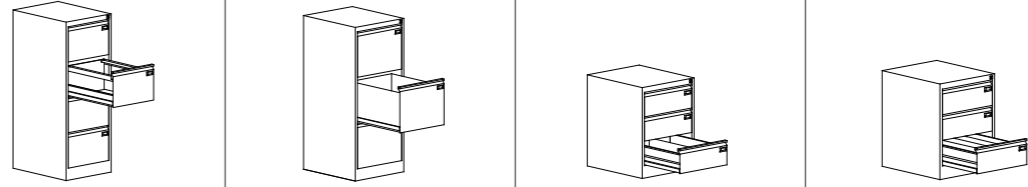
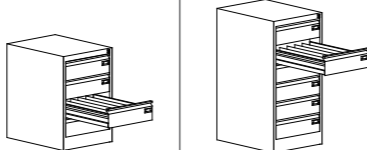
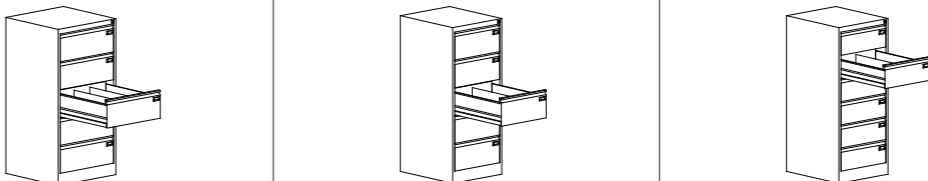
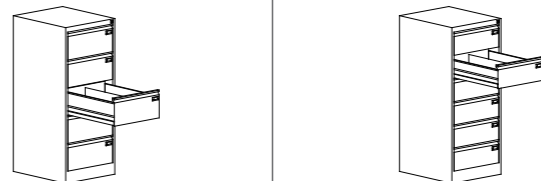
			
Designation	Szk 103	Szk 203	Szk 303
Code	SZK 02011401	SZK 02021501	SZK 02031601
Height (mm)	715	1000	1285
Width (mm)	775		775
Depth (mm)	630		630
Number of shelves	4	6	8
Number of rows per drawer	4		4
Internal dimensions of drawers (mm)	H x W x D: 100 (front 137) x 690 x 585		H x W x D: 100 (front 137) x 690 x 585
Size	A6		A6
			
Designation	Szk 104	Szk 204	Szk 306
Code	SZK 04010501	SZK 04020601	SZK 04030701
Height (mm)	715	1000	1285
Width (mm)	481		481
Depth (mm)	630		630
Number of shelves	2	3	4
Number of rows per drawer	1		1
Internal dimensions of drawers (mm)	H x W x D: 244 (front 280) x 398 x 585		H x W x D: 244 (front 280) x 398 x 585
Size	Din A4, Folio, Grand Folio		Din A4, Folio, Grand Folio
			
Designation	Szk 117	Szk 215	Szk 319
Code	SZK 07013102	SZK 07023202	SZK 09032202
Height (mm)	715	1000	1285
Width (mm)	470		610
Depth (mm)	630		630
Number of shelves	4	6	5
Number of rows per drawer	5		3
Internal dimensions of drawers (mm)	H x W x D: 95 (front137) x 382 x 585		H x W x D: 150 (front 223) x 522 x 585
Size	103 x 72 mm		215 x 170 mm
			
			Szk 320
			Szk 321
			SZK 06032502
			SZK 06032402
			1285
			520
			630
			6
			2
			H x W x D: 105 (front 223) x 432 x 585
			H x W x D: 105 (front 223) x 432 x 585
			180 x 213 mm

# OFFICE FURNITURE



## FILING CABINETS

We provide highly popular filing cabinets for A5 (horizontally and vertically), B5 (horizontally) files. A great variety of possible heights allows for adjusting cabinet to every interior and different needs of users.

Additional equipment – available at an extra cost.  
 - drawers support,  
 - top plates (selection of the top plates on page 79).

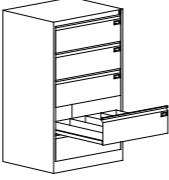
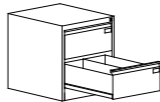
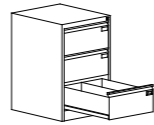

### TECHNICAL SPECIFICATION

						
Designation	Szk 305		Szk 304/2	Szk 304/3	Szk 304/4	Szk 304
Code	SZK 02031301		SZK 03063401	SZK 03073501	SZK 03083601	SZK 03031101
Height (mm)	1285		605	830	1060	1285
Width (mm)	775		545			
Depth (mm)	630		630			
Number of shelves	5		2	3	4	5
Number of rows per drawer	4		2			
Internal dimensions of drawers (mm)	H x W x D: 100 (front 223) x 690 x 585		H x W x D: 187 (front 223) x 460 x 585			
Size	A5 vertically		A5 horizontally			

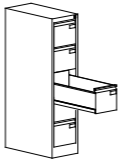
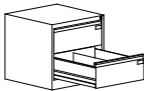
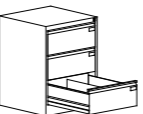
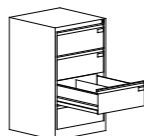
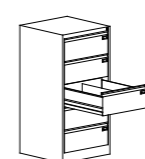
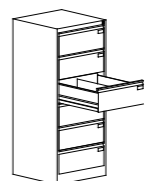
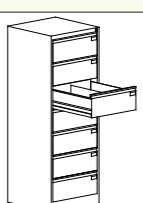
							
Designation	Szk 318/1/5	Szk 318/2	Szk 318/3	Szk 318/4	Szk 318	Szk 318/6	Szk 318/7
Code	SZK 11035002	SZK 09064502	SZK 09074602	SZK 09084702	SZK 09032102	SZK 09134802	SZK 09154902
Height (mm)	1285	605	830	1060	1285	1510	1740
Width (mm)	345	610	610				
Depth (mm)	630		630				
Number of shelves	5	2	3	4	5	6	7
Number of rows per drawer	1	2	2				
Internal dimensions of drawers (mm)	H x W x D: 150 (front 223) x 262 x 585	H x W x D: 150 (front 223) x 522 x 585	H x W x D: 150 (front 223) x 522 x 585				
Size	B5 vertically		B5 horizontally				

# OFFICE FURNITURE

## SCD CABINETS FOR CD'S

CD's can be kept in three rows – 22 pieces in each row. CD's supporters inside the drawer are movable. Each drawer can be labelled thanks to the self-adhesive card-holders placed on the front of the drawer. Drawer's full extension enables easy access to all CD's. Drawers are equipped with a central locking mechanism. Drawers are installed on double extension telescopic ball bearing slides, protected against falling out. Top plate as standard. Selection of top plates on p. 79.



### TECHNICAL SPECIFICATION

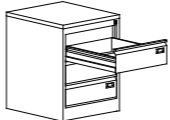
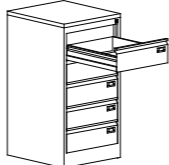
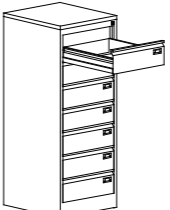

			
Designation	Scd 33	Scd 35	Scd 37
Code	SZK 08041802	SZK 08051902	SZK 08032002
Height (mm)	630	956	1285
Width (mm)	505	505	505
Depth (mm)	565	565	565
Number of shelves	3	5	7
Number of rows per drawer	3	3	3
Internal dimensions of drawers (mm)	height x depth 155 x 505	height x depth 155 x 505	
Number of stored discs	3 rows x 22 x 3 drawers = 198 discs	3 rows x 22 x 5 drawers = 330 discs	3 rows x 22 x 7 drawers = 462 discs

# OFFICE FURNITURE

## SRM DRAWING CABINETS

Cabinets for keeping drawings, maps, printing plates and technical documentation that ensure safe, practical and organized storage of these materials. Cabinets are designed for A0/A1 sizes.



For individual requirements of our customers we are able to divide drawers, with additional partitions, into various sizes – from A4 to A1.

Maximum loading capacity of each drawer is approx. 50 kg. Drawers are installed on full extension ball bearing slides protected against falling out. Center cylinder lock secures all drawers. The cabinets can be placed directly on the floor or on the pedestals.



### TECHNICAL SPECIFICATION

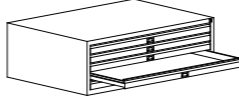
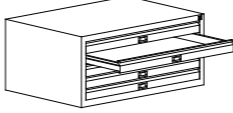
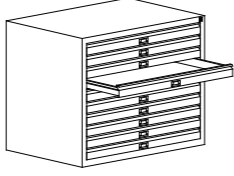

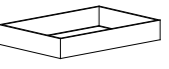
					
Designation	Srm 100	Srm 101	Srm 201	Srm 100 socle	Srm 101, Srm 201 socle
Code	SRM 02010102	SRM 01010102	SRM 01020102	CSRSM 0201	CSRSM 0101
Height (mm)	425	425	770	140	
Width (mm)	1315	970		1290	945
Depth (mm)	920	670		895	645
Internal dimensions of drawers (mm)	height x width x depth 45 x 1235 x 895		height x width x depth 45 x 890 x 630		
Number of drawers	5	5	10	-	
Size	A0	A1		A0	A1



# OFFICE FURNITURE

## CLASSROOM FURNISHING E-CLASS

### CLASSROOM FURNISHING

Cabinets are designed for keeping and sorting documents, mail etc. They are perfectly suitable for places such as reading rooms or staffrooms, e.g. for storing registers. The cabinets are equipped with adjustable shelves. The Sbmk 1 cabinet is additionally equipped with an extendable desk and a locked compartment.

### E-CLASS

We offer complex furnishing of modern multimedia classrooms. Our offer includes: laptop and tablet lockers and trolleys. Modern desks, lockers with compartments for books and school supplies, filing cabinets.

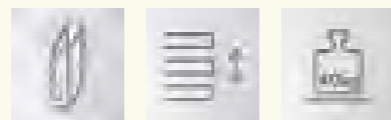

## TECHNICAL SPECIFICATION

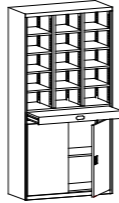
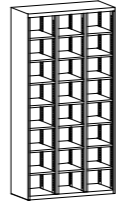
		
Designation	Sbmk1	Sbmk2
Code	SBMK 01010202	SBMK 01010101
Height (mm)	1990	1990
Width (mm)	1000	1000
Depth (mm)	435	435
Number of shelves	12	21



# OFFICE FURNITURE

## SKT CABINETS FOR CATALOGUES

Cabinets for catalogues allow to organize and systematize the collection in each library.

The body of the cabinet is made of sheet steel, painted powder paint.

Cabinet equipped with extended drawers on ball bearing slides, with see-through front made of plexi glass, adapted to catalogue cards of size 110 x 170 mm (Skt 1) or cards of size 125 x 75 mm (Skt 2).

Drawers are protected against removing the card. Cabinets are placed on the basis from closed profile # 40 x 40 mm with adjustable height.

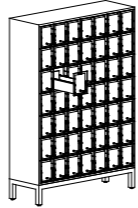
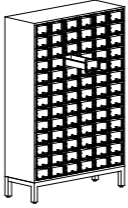

### TECHNICAL SPECIFICATION

		
Designation	Skt 1	Skt 2
Code	SKT 01010101	SKT 02020102
Height (mm)	1645	1635
Width (mm)	1150	1080
Depth (mm)	390	390
Internal dimensions of drawers (mm)	H x W x D: 95 (front 190) x 120 x 350	H x W x D: 65 (front 90) x 135 x 350
Number of shelves	49	78
Maximal size of files	110 x 170	125 x 75



# OFFICE FURNITURE

## LIBRARY RACKS

Library racks – ideal for reading room. Racks are equipped with vertical separators and supports for books, newspapers and other documents, with information label on each module. Rack's frame is made of steel closed profile. Adjustable feet. Shelves adjustable every 50 mm. Racks are produced in two versions – as single side and double side racks.

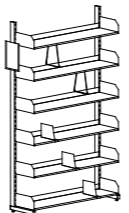
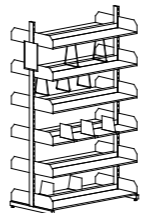

### TECHNICAL SPECIFICATION

		
Designation	Rmb 1	Rmb 2
Code	RMB 0101010101	RMB 0101010201
Height (mm)	2060	2060
Width (mm)	1030	1030
Depth (mm)	310	560
Number of shelves	6	12 (6 on each side)
Equipment	compartments – 12, book supports – 6	compartments – 24, book supports - 12



# OFFICE FURNITURE

## STB OFFICE DESKS

Thanks to its minimalistic form and timeless design STB COMFORT desks match in all interiors.

Desks are based on solid 50 x 50 mm square profile legs. Legs of tables are equipped with adjustable feet allowing for height levelling.

The cable duct under the top enable to store cables, power supply or power strip in an aesthetic way. Table tops are made from top-quality 18 mm thick melamine covered board or 16 mm thick MDF board.

Black veneer of tops' edges creating the unique character of STB comfort office desks.

Tables are delivered in parts to allow easy assembly.



### TECHNICAL SPECIFICATION

Designation	Stb 1060		Stb 1260	Stb 1460	Stb 1660	Stb 1860
Code	MST 0101010101		MST 0201010101	MST 0301010101	MST 0401010101	MST 0501010101
Height (mm)	745+770		745+770			
Width (mm)	1000		1200	1400	1600	1800
Depth (mm)	600		600			

Designation	Stb 1080		Stb 1280	Stb 1480	Stb 1680	Stb 1880
Code	MST 0601010101		MST 0701010101	MST 0801010101	MST 0901010101	MST 1001010101
Height (mm)	745+770		745+770			
Width (mm)	1000		1200	1400	1600	1800
Depth (mm)	800		800			



# OFFICE FURNITURE

## DESKS CONNECTORS

Available options of desks equipment:

- perforated front cover,
- desks connectors,
- accessories: cable connector, cable duct.

Desk-connector configuration:

- half-round connector,
- quarter round connector.



For the greater user comfort there is a possibility of ordering front covers. These covers allow to hide from view things that are under the desk and additionally, they separate legs of interlocutors.



Front covers are made of the powder coated metal sheet. The holes in the cover are cut with laser, which aesthetically distinguishes them from other metal covers.

Thanks to desk connectors it is possible to adjust desk arrangement depending on space and shape of a room.

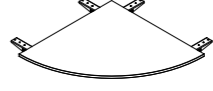

### TECHNICAL SPECIFICATION

					
Designation	half-round connector 60		half-round connector 80	quarter round connector 60	quarter round connector 80
Code	XMST 02060202		XMST 02070202	XMST 03080202	XMST 03090202
Height (mm)	745+770		745+770		
Width (mm)	1200		1600	600	800
Depth (mm)	600		800	600	800

						
Designation	front cover 10		front cover 12	front cover 14	front cover 16	front cover 18
Code	XMST 01010101		XMST 01020101	XMST 01030101	XMST 01040101	XMST 01050101
Height (mm)	330		330			
Width (mm)	846		1046	1246	1446	1646



# OFFICE FURNITURE

## SZP MOBILE PEDESTALS

Mobile pedestals of proved quality allow for practical equipping of office space. Thanks to the application of the highest quality steel SZP mobile pedestals are extremely long-lasting and stable. Full extension ball bearings slides provide smooth and simple extension of drawers.

SZP mobile pedestals are equipped with central locking system opening and closing all the drawers at the same time.

Available mobile pedestals:

- lower (520 mm high), able to be used as a seat,
- higher (663 mm high) allow to use the space under the desk to the maximum.

The top of SZP mobile pedestals is made of the 18 mm thick melamine covered plate, or of 16 mm MDF board. Choosing either metal or melamine covered plate fronts makes it possible to adjust them to each interior.

We offer two types of containers: with 2 and 3 drawers. Pedestals equipped with 4 swivel wheels, including 2 wheels with brakes. They are covered with melamine top or MDF (optional).

Drawers are installed on full extension ball bearing slides:

- 45 kg load capacity. Drawers' size: 330 x 420 mm.



Pedestals are locked with a central lock placed on the right side of pedestal.

Mobile pedestal accessories:

- plastic pencil box as an insert,
- fronts of drawers made of melamine covered plate.

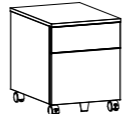

### TECHNICAL SPECIFICATION

				
Designation	Szp 520	Szp 530	Szp 630	Szp 640
Code	MSZP 0101010101	MSZP 0101020101	MSZP 0102030101	MSZP 0102040101
Height (mm)	517	517	662	
Width (mm)	417	417		
Depth (mm)	556	556		
Equipment	1 high drawer 1 low drawer	3 low drawers	1 high drawer 2 low drawers	4 low drawers

# OFFICE FURNITURE

## TABLE TOPS

Table tops have a wide range of applications: in offices, studies and objects on open-space. They are characterized by a modern design, with the functionality and the ergonomics of the service. Legs of the table are equipped with adjustable feet. The construction enables to hide cables in cable trays.

### COLOURS OF TOPS:

- Grey,
- Cream,
- White,
- Black,
- Beech (at an extra cost).

Black veneer of tops.

### CABLE DUCT:

A horizontal structural beam under the top strengthens the stiffness of the construction and simultaneously it serves as a horizontal channel allowing for an aesthetic hiding of wires. This ensures that all your cables are in their place and do not make a mess under the desk and worksite looks exceptionally aesthetically pleasing.

#### STANDARD

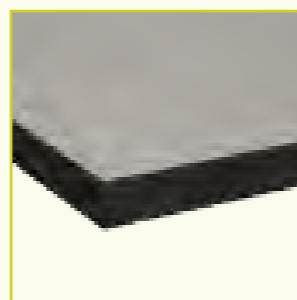

Grey



Cream

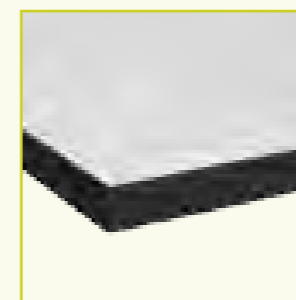

White



Black



Beech

#### AT AN EXTRA COST



# SOCIAL FURNITURE

*Furniture  
you can depend on*



# SOCIAL FURNITURE

## CONTENTS

SUM W Wardrobe lockers	84
SUL W Wardrobe lockers	92
SUS W Lockers with compartments	98
SUS W Lockers with compartments - 300mm module	100
SUS W Lockers with compartments - 400mm module	104
Slanted tops and socles for WSU wardrobe lockers	108
Benches for WSU wardrobe lockers	110
School lockers	114
Laptop and iPads trolleys	118
Laptop and mobile phones lockers	120
Social lockers with MDF doors	122
KBS Lockers for cleaning purposes	126
SMD Lockers for cleaning purposes	128
Lockers for fire fighters	130
MPO Metal recycling bin	132
Sport rockers	134
Tables, benches, chairs and stands	138
Furniture on special request – examples	140

Metal social furniture guarantees functionality and an aesthetic value of social spaces in factories, schools, sports halls, fitness clubs, swimming pools etc. Proper arrangement of those rooms, taking into consideration a wide range of requirements and needs, guarantees a sense of well-being and increases the standards of workplace.

The main advantage of SUM W, SUS W, SUL W lockers produced on the new line is advanced construction based on closed profiles, which are implemented in sides of doors, in the middle of the body and in the bottom of a locker. Lockers are certified, approved and they meet EU safety standards.

Doors perforation have registered as an industrial design.

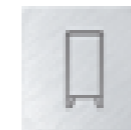

Wardrobes on legs



Wardrobes with slanted top



Height-adjustable feet



The possibility of hanging clothes



On wheels



Made of galvanized steel sheet



Made of acid proof stainless steel sheet



Made of stainless steel sheet



Various types of locks



Master system



With electrical components - safe



Ventilation and ventilation with heating



Standard equipment



Standard equipment



Door opening angle 180°



110° Door swing angle



Possibility of fixing



Possibility of mounting to a wall



# SOCIAL FURNITURE

## SUM W WARDROBE LOCKERS



bar with hook

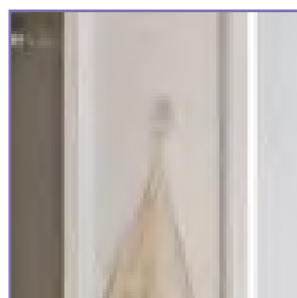

hook for towel

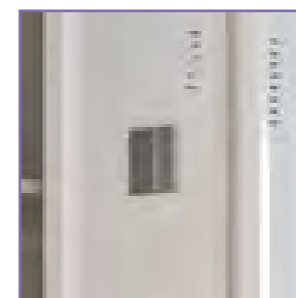

mirror

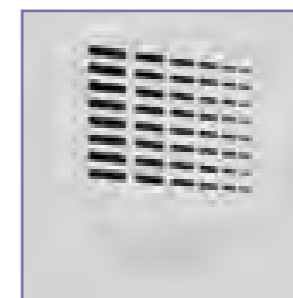

self adhesive nameplate

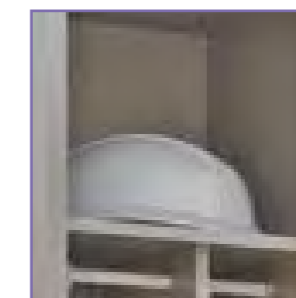

shelf

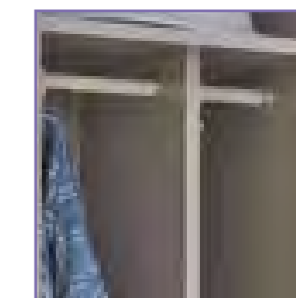

internal partition (in 400 mm wide modules)

Wardrobe lockers allow furnishing social rooms in a functional and aesthetic way. Wide assortment guarantees fulfilling even the most varied user needs. Ventilation in cabinets is done through a system of perforation which allows free circulation of air. Welded construction based on closed profiles affects the rigidity of the wardrobes.

**SUM W WARDROBE LOCKERS ARE MADE IN TWO WIDTHS:**

- 300 mm,
- 400 mm (with internal partition to separate clean from dirty clothes).

**STANDARD EQUIPMENT:**

- bar with hooks,
- hook for towel,
- mirror,
- self adhesive nameplate,
- shelf above the bar,
- internal partition (in 400 mm wide modules).



**LOCKERS TO THE MEDAL**





# SOCIAL FURNITURE

## SUM W WARDROBE LOCKERS

Thanks to additional equipment our social cabinets meet customer's requirements and expectations in 100%.

Slanted tops help maintain cleanness, and socles and benches provide the functionality and ergonomics.

Seats of the benches consist of three wooden slats coated with clear varnish or three plastic slats.

All benches increase the height of the cabinet by 390mm.



### ADDITIONAL EQUIPMENT



slanted top



socle screwed with locker (140mm high)



leg-frame with legs (140mm high)



bench without seat equipped with adjustable feet



bench with seat equipped with adjustable feet



bench with seat equipped with adjustable feet – economical version



extendable bench equipped with adjustable feet



bench without seat equipped with adjustable feet – economical version

### TYPES OF LOCKS

In social wardrobes it is possible to have a key lock (C) or a handle which is adapted to hang a padlock (D) on it.

There is a possibility to order lockers with MASTER key which allows opening certain number of locks.

Locks available at an extra cost:

- cylindrical damp-proof lock,
- coin locks (E) – coin lock with return (F) or coin locks without return (G),
- mechanical (H) and electronic code locks (I) and others – on customer's request.

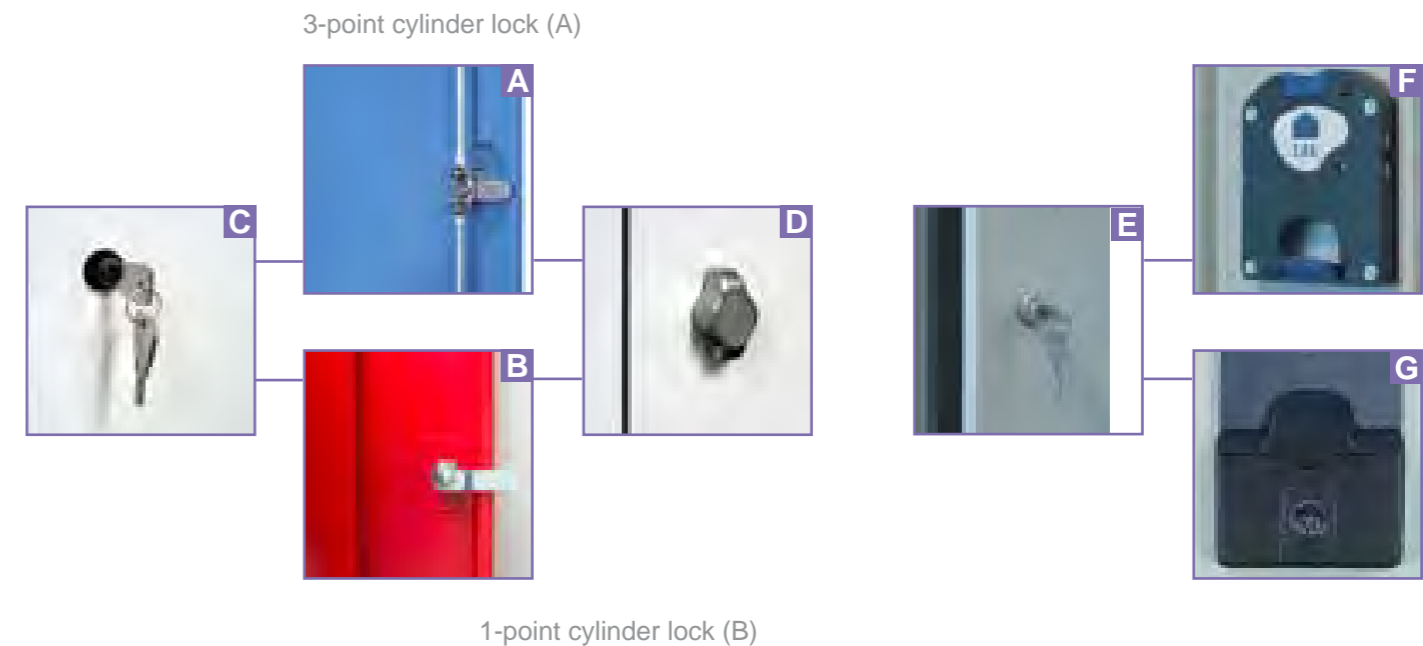
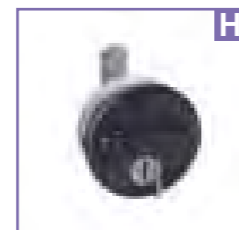

# SOCIAL FURNITURE

## SUM W WARDROBE LOCKERS

### ADVANTAGES OF THE WARDROBES:

- the standard wide range of equipment,
- 16 colours at no extra cost,
- various types of locks to choose,
- socles, bases, legs, slanted tops etc.,
- increased usable space,
- seals of approval, certificates, declarations.



### ADVANTAGES OF THE WARDROBES



### LOCKERS TO THE MEDAL

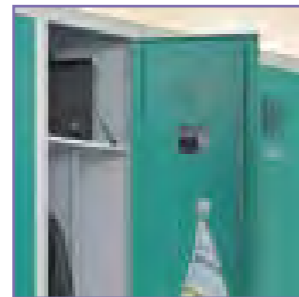

standard wide range of equipment



16 colours at no extra cost



various types of locks to choose



socles, bases, legs, slanted tops etc.



different price versions

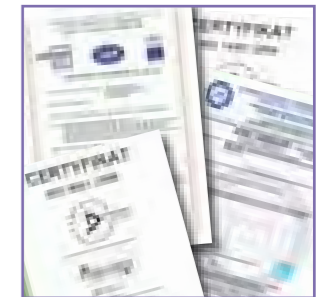

seals of approval, certificates, declarations



# SOCIAL FURNITURE

## SUM W WARDROBE LOCKERS

SUM W Wardrobe lockers												
	Designation	Sum 310 W	Sum 311 W	Sum 320 W	Sum 321 W	Sum 330 W	Sum 331 W	Sum 340 W	Sum 341 W			
Code	WSU 0101020102	WSU 0101020202	WSU 0102020102	WSU 0102020202	WSU 0103020102	WSU 0103020202	WSU 0104020102	WSU 0104020202				
Height (mm)	1800	1940	1800	1940	1800	1940	1800	1940				
Width (mm)		300	600		900		1200					
Depth (mm)		500	500									
Number of units		1	2		3		4					
Number of doors		1	2		3		4					
Legs	-	+	-	+	-	+	-	+	-	+		

SUM W Wardrobe lockers										
	Designation	Sum 410 W	Sum 411 W	Sum 420 W	Sum 421 W	Sum 430 W	Sum 431 W			
Code	WSU 0201020103	WSU 0201020103	WSU 0202020103	WSU 0202020203	WSU 0203020103	WSU 0203020203				
Height (mm)	1800	1940	1800	1940	1800	1940				
Width (mm)		400	800		1200					
Depth (mm)		500	500							
Number of units		1	2		3					
Number of doors		1	2		3					
Legs	-	+	-	+	-	+				



# SOCIAL FURNITURE

## SUL W WARDROBE LOCKERS

### SUL W WARDROBE LOCKERS

In order to make use of small spaces as cloakrooms, an ideal solution is our L-shape wardrobe locker.

Thanks to SUL W lockers, one can place twice as many wardrobe compartments than in the case of standard wardrobe lockers.

Welded construction based on closed profiles affects the rigidity of the wardrobes.



### ADVANTAGES OF THE WARDROBES



### LOCKERS TO THE MEDAL



standard wide range of equipment



16 colours at no extra cost



various types of locks to choose



socles, bases, legs, slanted tops etc.



different price versions

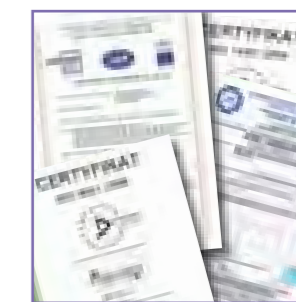

seals of approval, certificates, declarations

# SOCIAL FURNITURE

## SUL W WARDROBE LOCKERS

### SUL W WARDROBE LOCKERS

Wardrobe lockers SUL W are made in two widths:  
- 300 mm,  
- 400 mm.

Ventilation in cabinets is done through a system of perforation which allows free circulation of air.

Available locks: 1-point lock.



### STANDARD EQUIPMENT



### LOCKERS TO THE MEDAL



1-point lock



bar with hook

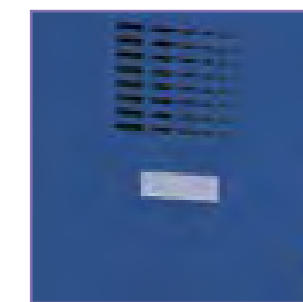

self adhesive nameplate





# SOCIAL FURNITURE

## SUM W WARDROBE LOCKERS

SUM W Wardrobe lockers									
	Designation	SUL 31 W		SUL 31 W	SUL 32 W	SUL 32 W	SUL 33 W	SUL 33 W	SUL 34 W
Code	WSU 0306030104	WSU 0306030204		WSU 0306030204	WSU 0307030204	WSU 0308030104	WSU 0308030204	WSU 0309030104	WSU 0309030204
Height (mm)	1800	1940		1800	1940	1800	1940	1800	1940
Width (mm)		300		600		900		1200	
Depth (mm)		500		500					
Number of units		2		4		6		8	
Number of doors		2		4		6		8	
Legs	-	+		-	+	-	+	-	+

SUM W Wardrobe lockers							
	Designation	SUL 41 W		SUL 41 W	SUL 42 W	SUL 42 W	SUL 43 W
Code	WSU 0406030104	WSU 0406030204		WSU 0407030104	WSU 0407030204	WSU 0408030104	WSU 0408030204
Height (mm)	1800	1940		1800	1940	1800	1940
Width (mm)		400		800		1200	
Depth (mm)	500			500			
Number of units		2		4		6	
Number of doors		2		4		6	
Legs	-	+		-	+	-	+



# SOCIAL FURNITURE

## SUS W WARDROBE LOCKERS

Lockers with compartments, thanks to their functionality, variety and aesthetic qualities can be used in a wide range of facilities, e.g. in cloakrooms, kindergartens, schools, boarding schools, swimming pools, fitness clubs, gyms, railway stations, workplaces - for storing briefcases, handbags, helmets etc.

Welded construction based on closed profiles affects the rigidity of the wardrobes.



### ADVANTAGES OF THE WARDROBES



### LOCKERS TO THE MEDAL



standard wide range of equipment



16 colours at no extra cost



various types of locks to choose



socles, bases, legs, slanted tops etc.



different price versions

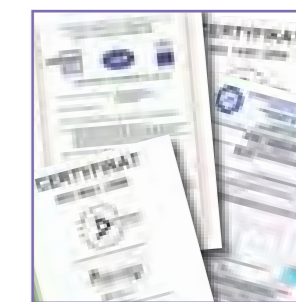

seals of approval, certificates, declarations

# SOCIAL FURNITURE

## SUS W WARDROBE LOCKERS - 300mm wide module

Depending on customer needs, we offer different types of SUS W cabinets with compartments:

- 300 mm and 400mm wide modules,
- different number of compartments: from 2 to 20.

Ventilation in cabinets is done through a system of perforation which allows free circulation of air.



### STANDARD EQUIPMENT





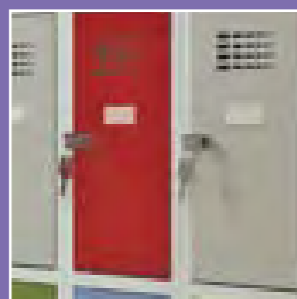

### TECHNICAL SPECIFICATION



bar with hooks (in lockers with two compartments in a row)



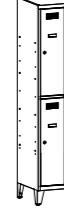











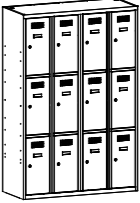

Self adhesive nameplate



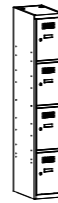

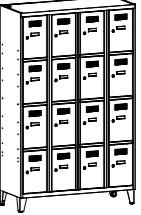

300mm wide modules								
Designation	SUS 312 W	SUS 312 W n	SUS 322 W	SUS 322 W n	SUS 332 W	SUS 332 W n	SUS 342 W	SUS 342 W n
Code	WSU 0106020104	WSU 0106020204	WSU 0107020104	WSU 0107020204	WSU 0108020104	WSU 0108020204	WSU 0109020104	WSU 0109020204
Height (mm)	1800	1940	1800	1940	1800	1940	1800	1940
Width (mm)	300		600		900		1200	
Depth (mm)	500							
Number of units	1		2		3		4	
Number of doors	2		4		6		8	
Legs	-	+	-	+	-	+	-	+

# SOCIAL FURNITURE

## SUS W WARDROBE LOCKERS - 300mm wide module

300mm wide modules									
	Designation	SUS 313 W	SUS 313 W n	SUS 323 W	SUS 323 W n	SUS 333 W	SUS 333 W n	SUS 343 W	SUS 343 W n
	Code	WSU 0111020101	WSU 0111020201	WSU 0112020101	WSU 0112020201	WSU 0113020101	WSU 0113020201	WSU 0114020101	WSU 0114020201
	Height (mm)	1800	1940	1800	1940	1800	1940	1800	1940
	Width (mm)	300		600		900		1200	
	Depth (mm)	500		500		500		500	
	Number of units	1		2		3		4	
	Number of doors	3		6		9		12	
Legs	-	+	-	+	-	+	-	+	

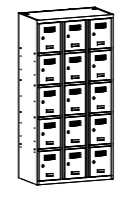
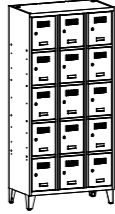
300mm wide modules									
	Designation	SUS 314 W	SUS 314 W n	SUS 324 W	SUS 324 W n	SUS 334 W	SUS 334 W n	SUS 344 W	SUS 344 W n
	Code	WSU 0116020101	WSU 0116020201	WSU 0117020101	WSU 0117020201	WSU 0118020101	WSU 0118020201	WSU 0119020101	WSU 0119020201
	Height (mm)	1800	1940	1800	1940	1800	1940	1800	1940
	Width (mm)	300		600		900		1200	
	Depth (mm)	500		500		500		500	
	Number of units	1		2		3		4	
	Number of doors	4		8		12		16	
Legs	-	+	-	+	-	+	-	+	

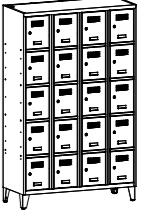
300mm wide modules									
	Designation	SUS 315 W	SUS 315 W n	SUS 325 W	SUS 325 W n	SUS 335 W	SUS 335 W n	SUS 345 W	SUS 345 W n
	Code	WSU 0121020101	WSU 0121020201	WSU 0122020101	WSU 0122020201	WSU 0123020101	WSU 0123020201	WSU 0124020101	WSU 0124020201
	Height (mm)	1800	1940	1800	1940	1800	1940	1800	1940
	Width (mm)	300		600		900		1200	
	Depth (mm)	500		500		500		500	
	Number of units	1		2		3		4	
	Number of doors	5		10		15		20	
Legs	-	+	-	+	-	+	-	+	

# SOCIAL FURNITURE



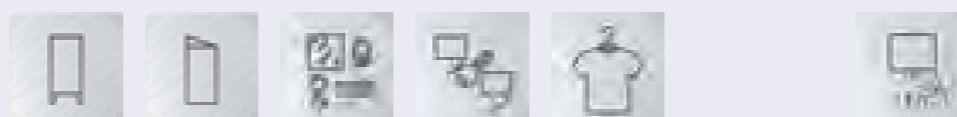

SUS W WARDROBE LOCKERS  
- 400mm wide module



## TECHNICAL SPECIFICATION

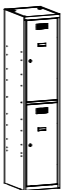

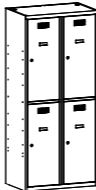

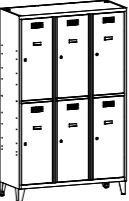
LOCKERS TO THE MEDAL





400mm wide modules						
Designation	SUS 412 W	SUS 412 W n	SUS 422 W	SUS 422 W n	SUS 432 W	SUS 432 W n
Code	WSU 0206020104	WSU 0206020204	WSU 0207020104	WSU 0207020204	WSU 0208020104	WSU 0208020204
Height (mm)	1800	1940	1800	1940	1800	1940
Width (mm)	400		800		1200	
Depth (mm)	500		500			
Number of units	1		2		3	
Number of doors	2		4		6	
Legs	-	+	-	+	-	+

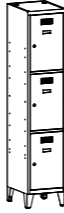
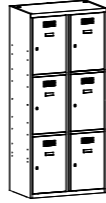
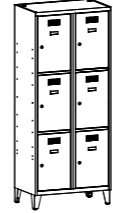

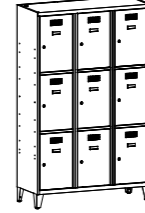

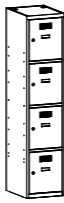

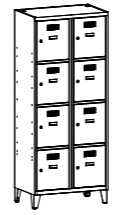
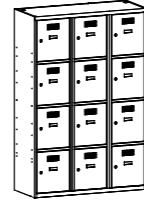

# SOCIAL FURNITURE

## SUS W WARDROBE LOCKERS - 400mm wide module

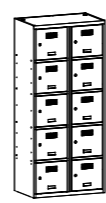
400mm wide modules							
	Designation	SUS 413 W	SUS 413 W	SUS 423 W	SUS 423 W	SUS 433 W	SUS 433 W
	Code	WSU 0211020101	WSU 0211020201	WSU 0212020101	WSU 0212020201	WSU 0213020101	WSU 0213020201
	Height (mm)	1800	1940	1800	1940	1800	1940
	Width (mm)	400		800		1200	
	Depth (mm)	500		500			
	Number of units	1		2		3	
	Number of doors	3		6		9	
	Legs	-	+	-	+	-	+

400mm wide modules							
	Designation	SUS 414 W	SUS 414 W	SUS 424 W	SUS 424 W	SUS 434 W	SUS 434 W
	Code	WSU 0216020101	WSU 0216020201	WSU 0217020101	WSU 0217020201	WSU 0218020101	WSU 0218020201
	Height (mm)	1800	1940	1800	1940	1800	1940
	Width (mm)	400		800		1200	
	Depth (mm)	500		500			
	Number of units	1		2		3	
	Number of doors	4		8		12	
	Legs	-	+	-	+	-	+

400mm wide modules							
	Designation	SUS 415 W	SUS 415 W	SUS 425 W	SUS 425 W	SUS 435 W	SUS 435 W
	Code	WSU 0221020101	WSU 0221020201	WSU 0222020101	WSU 0222020201	WSU 0223020101	WSU 0223020201
	Height (mm)	1800	1940	1800	1940	1800	1940
	Width (mm)	400		800		1200	
	Depth (mm)	500		500			
	Number of units	1		2		3	
	Number of doors	5		10		15	
	Legs	-	+	-	+	-	+



# SOCIAL FURNITURE

## SLANTED TOPS AND SOCLES FOR WSU WARDROBES



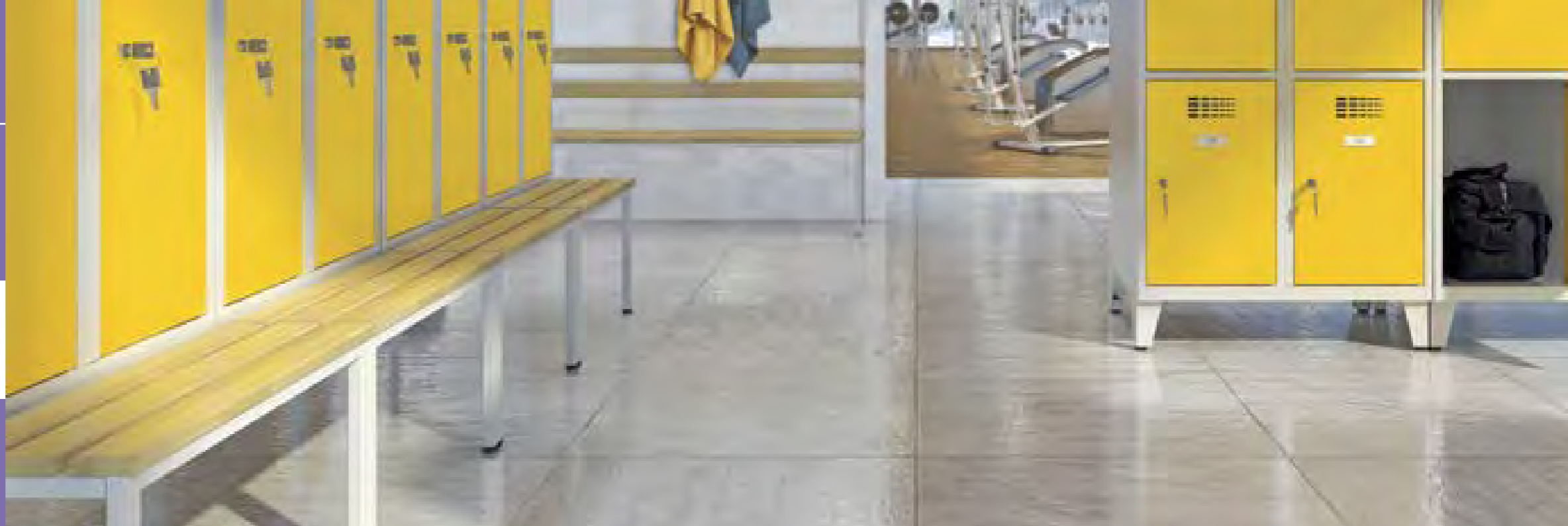

Wardrobes can be equipped with slanted tops that help maintain the cleanliness in social spaces.

- Slanted tops help to maintain the cleanness on top of the locker by making it easy to sweep and dust.
- Simple assembly - with latches.

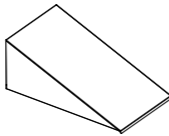
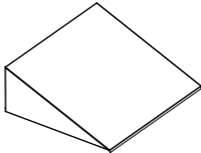
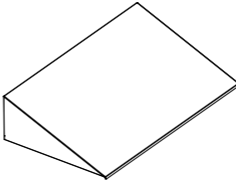
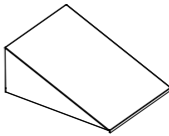
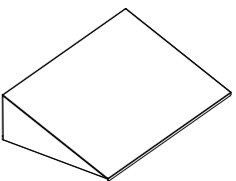
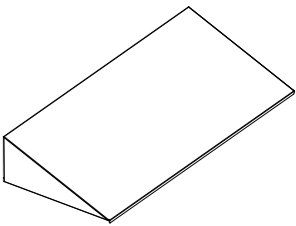

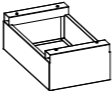
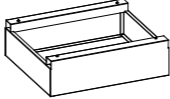
### TECHNICAL SPECIFICATION

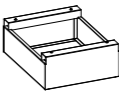
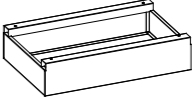
Slanted tops						
Designation	D310 W	D320 W	D330 W	D410 W	D420 W	D430 W
Code	DWSU 010101	DWSU 010102	DWSU 010103	DWSU 020101	DWSU 020102	DWSU 020103
Height (mm)	200		200			
Width (mm)	300	600	900	400	800	1200
Depth (mm)	500		500			

Socles							
Designation	C310 W	C320 W	C330 W	C340 W	C410 W	C420 W	C430 W
Code	CWSU 010101	CWSU 010102	CWSU 010103	CWSU 010104	CWSU 020101	CWSU 020102	CWSU 020103
Height (mm)	140		140				
Width (mm)	300	600	900	1200	400	800	1200
Depth (mm)	450		450				



# SOCIAL FURNITURE

## BENCHES FOR WSU WARDROBE LOCKERS

Cabinets can be placed on benches, and then fixed with screws.

The seat consists of three wooden slats coated with clear varnish or plastic slats, especially recommended for use in wet environments.

We offer 2 price versions:

- standard (frame and legs are made of closed profiles),
- economic (frame is made of bent steel sheet, legs of closed profiles).

In our offer, we have very practical, extendable benches which help to save space. These benches are ideal where it is essential to organize a space effectively. The bench has an extendable seat, which fits under the wardrobe.

All bases increase the height of cabinets by 390mm.

Bench with legs								
	WCn 311 W	WCn 321 W	WCn 331 W	WCn 341 W	WCn 411 W	WCn 421 W	WCn 431 W	
Designation	WCn 311 W	WCn 321 W	WCn 331 W	WCn 341 W	WCn 411 W	WCn 421 W	WCn 431 W	
Code	PWSU 09020101	PWSU 09020201	PWSU 09020301	PWSU 09020401	PWSU 10020101	PWSU 10020201	PWSU 10020301	
Height (mm)	140		140		140		140	
Width (mm)	275	575	875	1175	375	775	1175	
Depth (mm)	450		450		450		450	

One-side benches								
	P311 W	P321 W	P321 W	P 331 W	P411 W	P 421 W	P 431 W	
Designation	P311 W	P321 W	P321 W	P 331 W	P411 W	P 421 W	P 431 W	
Code	PWSU 01010102	PWSU 01010103	PWSU 01010202	PWSU 01010302	PWSU 01010303	PWSU 02010202	PWSU 02010302	
Height (mm)	390		390		390		390	
Width (mm)	290	590	590	890	390	790	1190	
Depth (mm)	745		745		745		745	
Wooden slats	+		+		+		+	
Plastic slats		+	+		+		+	

One-side benches – economic version								
	P313 W	P323 W	P323 W	P 333 W	P413 W	P 423 W	P 433 W	
Designation	P313 W	P323 W	P323 W	P 333 W	P413 W	P 423 W	P 433 W	
Code	PWSU 05010102	PWSU 05010103	PWSU 05010202	PWSU 05010302	PWSU 05010303	PWSU 06010202	PWSU 06010302	
Height (mm)	390		390		390		390	
Width (mm)	290	590	590	890	390	790	1190	
Depth (mm)	745		745		745		745	
Wooden slats	+		+		+		+	
Plastic slats		+	+		+		+	



# SOCIAL FURNITURE

## BENCHES FOR WSU WARDROBE LOCKERS

Benches without a seat							
	P311 W		P321 W	P331 W	P411 W	P421 W	P431 W
	PWSU 01010101		PWSU 01010201	PWSU 01010301	PWSU 02010101	PWSU 02010201	PWSU 02010301
	390		390				
	290		590	890	390	790	1190
490		490					

Benches without a seat – economical version							
	P313 W		P323 W	P333 W	P413 W	P423 W	P433 W
	PWSU 05010101		PWSU 05010201	PWSU 05010301	PWSU 06010101	PWSU 06010201	PWSU 06010301
	390		390				
	290		590	890	390	790	1190
490		490					

Extendable benches												
	Pw311 W		Pw321 W	Pw331 W	Pw411 W	Pw421 W	Pw431 W					
	PWSU 07010102	PWSU 07010103	PWSU 07010202	PWSU 07010203	PWSU 07010302	PWSU 07010303	PWSU 08010102	PWSU 08010103	PWSU 08010202	PWSU 08010203	PWSU 08010302	PWSU 08010303
	390		390									
	290		590	590	890		390		790		1190	
	745		745									
	+			+		+		+		+		+
			+		+		+		+		+	

# SOCIAL FURNITURE

## SCHOOL LOCKERS

School lockers are made of prime quality steel sheet. For additional protection against corrosion, the bottom of the cabinet is made of zinc coated sheet. We use powder paintings from leading global manufacturers.

Wide range of standard colours – 16 RAL colours.

As a standard we offer a cylindrical lock blocking in 1 or 3 points (in selected products).

There is also a possibility to order other locks according to individual needs. Most of our lockers can be placed on the benches or with legs.

Lockers of our production have declarations and certificates of compliance with Polish and European norms, as well as hygienic certificate issued by PZH ( National Institute of Public Health).

1450 mm high wardrobe locker is destined to younger pupils. In the doors of the lockers there are ventilation holes allowing for free exchange of the air in the locker.

Lockers with compartments are made in different price versions – depending on the thickness and type of steel sheet of which they are made (including galvanized, acid-proof steel).

We also offer lockers with compartments with additional equipment as follows:

- bar with hooks,
- book shelf, notebook, handheld things.



### ADVANTAGES OF LOCKERS

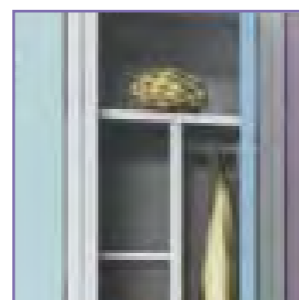

rich equipment as a standard



16 standard colours



different types of locks



socles, bases, legs, slanted tops, etc.



different price version

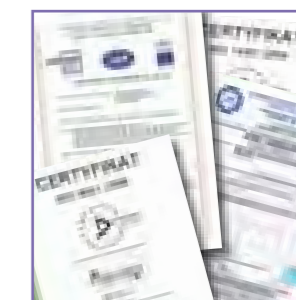

seals of approval, certificates, declarations



# SOCIAL FURNITURE

## SCHOOL LOCKERS

### SUM S CABINETS FOR PRESCHOOLERS

In our offer we also have Sum S lockers 1350mm high for kindergarten children. Even the youngest children will be able to hang their clothes and reach the shelves without any effort.

Cloakroom for children equipped with wardrobe lockers enhances children's independence. Children who have their own, individual lockers, more willingly and actively prepare to their classes.

The standard locker is lockable with a cylinder lock blocking in one point.

Other options of the lock:

- locking in 3 points,
- handle with magnet closure.

### SUM S LOCKER FOR 6-YEAR-OLDS

Sum S locker is 1500 mm high, so younger children have more space comparing to Sus lockers with compartments, and they can hang their clothes and reach the shelves easily.

Locker is equipped with a bar with hooks, hook doors and shelves for storing books, notebooks and handheld things.



## TECHNICAL SPECIFICATION

SUM S CABINETS for preschoolers		
	SumS 310	SumS 320
Designation	SumS 310	SumS 320
Code	SUM 1702020510	SUM 1802020510
Height (mm)	1500	
Width (mm)	300	600
Depth (mm)	500	
Number of units	1	2
Number of doors		

SUM S CABINETS for preschoolers		
	SumS 330	SumS 340
Designation	SumS 330	SumS 340
Code	SUM 1902020510	SUM 2002020510
Height (mm)	1500	
Width (mm)	900	1200
Depth (mm)	500	
Number of units	3	4
Number of doors		

SUM S Locker for 6-year-olds				
	SumS 310p	SumS 320p	SumS 330p	SumS 340p
Designation	SumS 310p	SumS 320p	SumS 330p	SumS 340p
Code	SUM 1703040112	SUM 1803040112	SUM 1903040112	SUM 2003040112
Height (mm)	1350			
Width (mm)	300	600	900	1200
Depth (mm)	500			
Number of units	1	2	3	4
Number of doors				



# SOCIAL FURNITURE

## LAPTOP/TABLET TROLLEYS

Trolley for laptops with function of battery charging is used to storage and easy transport of laptops. It is ideal for schools, colleges, libraries, conference halls, or anywhere where there is a need for secure storage and simultaneous laptops charging. Trolley WNL is particularly useful in a classroom, where students need to charge laptops and store them safely. Thanks to the mobile trolley WNL can be easily and safely moved with laptops from one class to another.



WNL trolley is used to store, secure and charge simultaneously from 10 to 30 laptops.

For the overload protection the sequencer is used, which enables to turn on the particular power strips after the specified time (~3 minutes) which results in a low maintenance of electrical load of the trolley during the charging process. A light-emitting diode is signalling the work of power strips of the laptop trolley.

The door of the trolley are protected against unauthorized access by a key lock with locking in two points. Trolley Laptop WNL was awarded the European Medal.

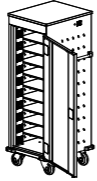
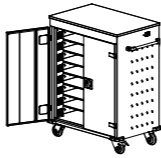

### TROLLEY TO THE MEDAL

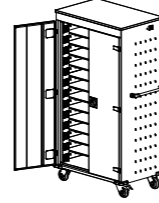
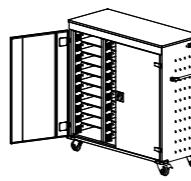
Laptop/tablet trolleys					
Designation	WNL 110	WNL 208	WNL 210	WNL 213	WNL 310
Code	WNL 0514060204	WNL 0615050404	WNL 0614050404	WNL 0616050404	WNL 0714050404
Height (mm)	1250	1060	1250	1540	1250
Width (mm)	530	920	920		1310
Depth (mm)	500		500		
Number of compartments	10	16	20	26	30

The trolley top is covered with melamine as a workspace. The frame has holes allowing for air circulation. Maximum laptop size: 90 x 340 x 470mm (17 inch). The trolley frame is made of metal sheet painted polyster-epoxy.

Trolley has a Certificate of Compliance to European Directive 2001/95 concerning product safety.



#### Work safety

A sequencer and 2 fuses against overloading protect against overload lines. Trolley has a Certificate of Compliance to European Directive 2001/95 concerning product safety.



#### Mobility

Easy moving thanks to swivel wheels diameter of 100mm covered in gum of non-marking surface (2 of them with brakes).



#### Ergonomics

Handles mounted on both sides and top make it easy to use.

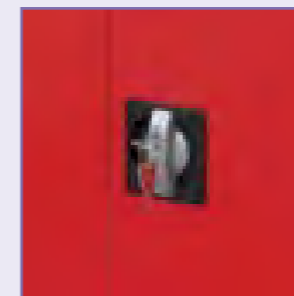

#### Security

Doors of the trolley are secured with a key lock in blocking in 2 points. Trolley side edges secured with rubber corners.



# SOCIAL FURNITURE

## LOCKERS FOR LAPTOPS / MOBILE PHONES

### LAPTOP LOCKER

Laptop lockers are designed to secure laptops with function of charging their batteries during storage. Inside the body a strip is mounted, which contains sockets for connecting chargers. Cabinet for laptops is also available in the version without electric installation.

### AND MOBILE PHONES LOCKERS

Cabinets for storing mobile phones are used in the pass desks, agencies, institutions, libraries, reading rooms and other places where we cannot use mobile phones. These cabinets can also be used as key deposits.



### TECHNICAL SPECIFICATION

Laptop locker		
Designation	Locker for laptops SZNL 4110	
Code	SZNL 0101010101	SZNL 0101010104
Height (mm)	1800	
Width (mm)	400	
Depth (mm)	500	
Number of compartments	10	
Description	Locker without wiring system	Locker with wiring system



WSS locker for mobile phones			
	WSS 5	WSS 10	WSS 20
Code	WSS 06010601	WSS 01010101	WSS 02010201
Height (mm)	780		
Width (mm)	210	390	750
Depth (mm)	200		
Number of compartments	5	10	20

WSS 30	WSS 35	WSS 50	WSS 55	WSS 60	WSS 80	WSS 90
WSS 03020301	WSS 07010701	WSS 03030801	WSS 03040901	WSS 04030401	WSS 05030501	WSS 08031001
930	780	1530	1680	1530		
930	1290	930		1110	1470	1650
200						
30	35	50	55	60	80	90

# SOCIAL FURNITURE

## SOCIAL FURNITURE WITH MDF DOORS

The cabinet with MDF doors is the perfect combination of excellent technical parameters of the metal cabinet with aesthetics and ecology of the MDF board.

MDF is an ideal substitute of wood with no structural imperfections such as knots or cracks which are typical for wood. Unified both composition and density makes it an ideal material. The use of colourful or wood-based fronts with MDF gives the wardrobe locker the effect of lightness, comfort and a unique appearance.

The doors of high quality laminated MDF.

Used galvanized hinges belts.



AVAILABLE COLOURS OF MDF DOORS

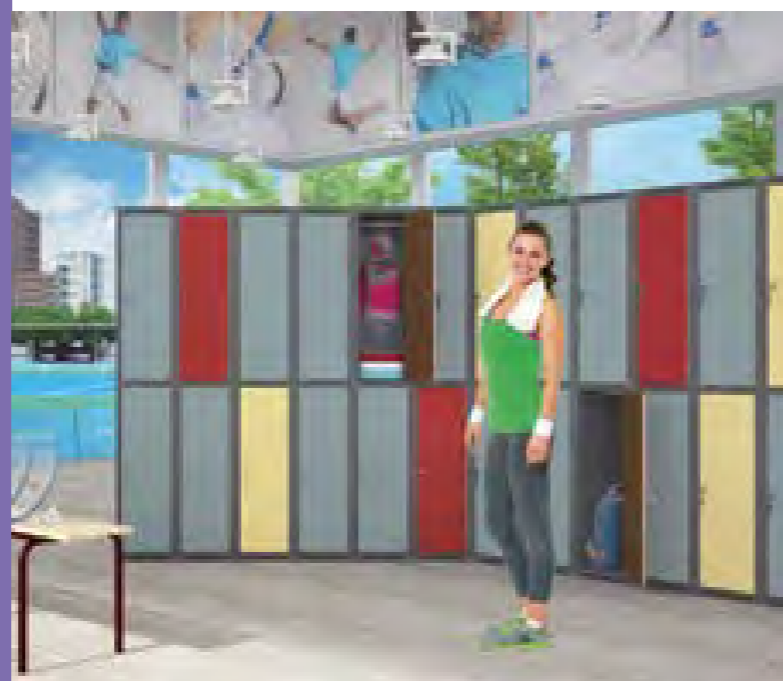
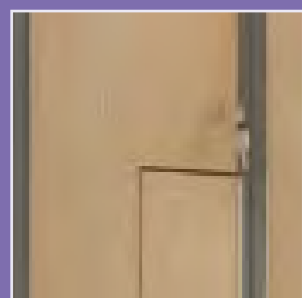

K 2081  
SPARTA



F 7024  
SAFFRON



F 7858  
PUMICE



F 2828  
TROPICAL BLUE



F 7845  
SPECTRUM RED

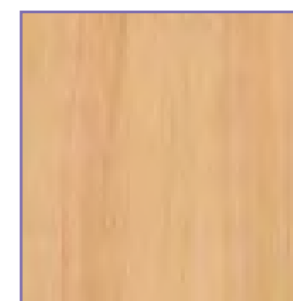

K 7024  
MAPLE

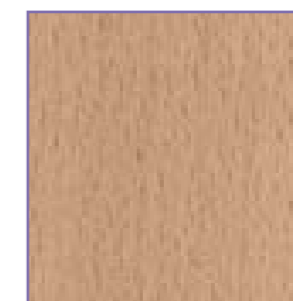

K 7016  
FINN BEECH





# SOCIAL FURNITURE

## SOCIAL LOCKERS WITH MDF DOORS

The cabinet has ventilation holes which provide proper air circulation in the cabinet. The bottom of the cabinet or base is protected against corrosion.

The bodies of the cabinets are made from high quality steel. Thickness of 0.8 - 1.0 mm. Painted high-quality powder coating.

The standard cylindrical lock with blocking in point.

SUS wardrobe locker with MDF doors						
	Designation	SUS 312	SUS 314	SUS 315	SUS 322	SUS 324
Code	NSUM 0106070104	NSUM 0116070101	NSUM 0121070101	NSUM 0107070104	NSUM 0117070101	NSUM 0122070101
Height (mm)	1800		1800			
Width (mm)	300		300	600		
Depth (mm)	490		490			
Number of compartments	2	4	5	4	8	10

SUS wardrobe locker with MDF doors						
	Designation	SUS 412	SUS 414	SUS 415	SUS 422	SUS 424
Code	NSUM 0306070104	NSUM 0316070101	NSUM 0321070101	NSUM 0307070104	NSUM 0317070101	NSUM 0322070101
Height (mm)	1800		1800			
Width (mm)	400		400	800		
Depth (mm)	490		490			
Number of compartments	2	4	5	4	8	10

SUM wardrobe locker with MDF doors		
	Designation	SUL 41
Code	NSUM 0606070104	NSUM 0607070104
Height (mm)	1800	
Width (mm)	400	800
Depth (mm)	490	
Number of doors	2	4

SUM wardrobe locker with MDF doors				
	Designation	SUM 310	SUM 320	SUM 410
Code	NSUM 0101070102	NSUM 0102070102	NSUM 0301070103	NSUM 0302070103
Height (mm)	1800			
Width (mm)	300	600	400	800
Depth (mm)	490			
Number of units	1	2	1	2



# SOCIAL FURNITURE

## KBS LOCKERS FOR CLEANING

*For easy, safe and pleasant work...*

KBS type cabinet is a very practical type of metal furniture both for the distribution of safety products and to store dirty clothes.

Each compartment is closed with an independent key, and common frame allows to open all the lockers at the same time.

The person distributing safety materials has an access to all the compartments, and thanks to this he or she can control the stock and regularly restock them.

The main advantage of KBS cabinets is a significant reduction of industrial safety products, and thus reducing costs.

Modules of the cabinet for dirty clothes allow throwing dirty clothes through the opening slot easily.

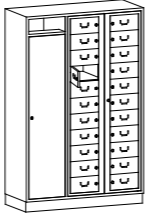
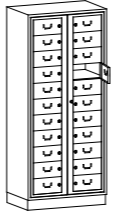
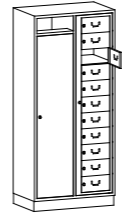
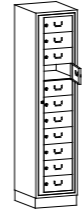

### TECHNICAL SPECIFICATION

KBS cabinet with compartments				
	KBS 1	KBS 2	KBS 3	KBS 4
Designation	KBS 1	KBS 2	KBS 3	KBS 4
Code	KBS 01050201	KBS 03050601	KBS 02050201	KBS 04050601
Height (mm)	1900		1900	
Width (mm)	1225	820	840	435
Depth (mm)	500		500	
Number of compartments	22 + compartment	22	11 + compartment	11

#### Facilitate the work

Provides easy access to safety products and / or storage dirty clothes.

#### Saving

Reduces the cost of safety products.

#### Control

Control of safety products consumption.

#### Functionality

A possibility of giving back and collecting new products.

# SOCIAL FURNITURE

## SMD CABINETS FOR CLEANING

Multifunctional cabinets are used to store clothes, household cleaners, buckets, brushes, etc. They facilitate the work of social workers and the cleaning services.

### FUNCTIONALITY

- Depending on the needs SMD cabinet is equipped with:
- 4 non-adjustable shelves (SMD 60) or
  - Compartment with shelves and wardrobe section (SMD 61) or
  - Compartment with shelves and compartment for a bucket and a brush (SMD 62).

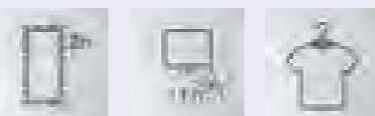

### TECHNICAL SPECIFICATION

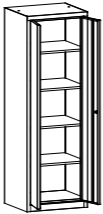
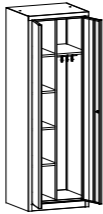
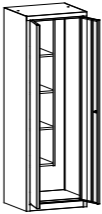
SMD cabinet for cleaning staff	 		
	SMD 60	SMD 61	SMD 62
Designation	SMD 60	SMD 61	SMD 62
Code	SAU 0401030201	SAU 0401030401	SAU 0401030501
Height (mm)	1800		1800
Width (mm)	600		600
Depth (mm)	500		500
Number of compartments	5	10	20



# SOCIAL FURNITURE

## LOCKERS FOR FIRE FIGHTERS

Fire lockers are used to store clothes by fire fighters during fire fighting actions.  
 Equipment of fireman lockers:

**Corrosion protection** – all parts made of galvanized steel.

For a greater air circulation it is possible to place the cabinet on the base.

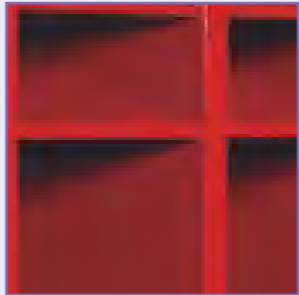
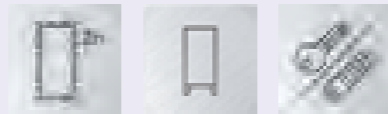

shelf



compartment closed with cylindrical key



storage handle for fire fighter helmets

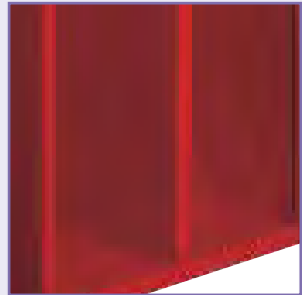

perforated bottom

### TECHNICAL SPECIFICATION

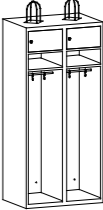

SMD cabinet for cleaning staff		
	SUS 41	SUS 42
Designation	SUS 41	SUS 42
Code	SST 07010201	SST 08010201
Height (mm)	1950	
Width (mm)	400	800
Depth (mm)	550	
Equipment	bar for clothes hooks for clothes helmet holder	

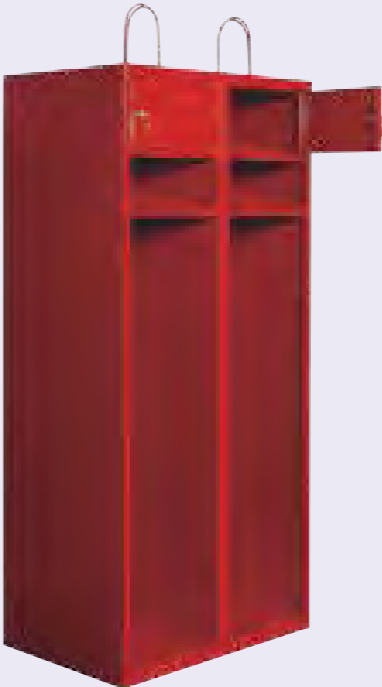



# SOCIAL FURNITURE

## MPO METAL RECYCLING BIN

Containers designed for internal use for various wastes, ex. plastic, paper, glass. The body made of 0.6-0.8mm thick steel sheet, powder coated. The slopping top prevents wastes from piling on the top of the container.

Self-closing lids prevent odours from emitting and closes the container in an aesthetic way. Containers allow gathering wastes in 120-litre disposal bag, or in internal, galvanized, metal containers of following dimensions: 700 x 295 x 357 mm (option at an extra cost).

Access to the container is simple, thanks to frontal winged doors locking with a free-turning latch lock with a possibility of padlock locking.

Extendable frame for disposal bags placed on full-extension ball bearings facilitates access to disposal bags.

Disposal bag is placed on a frame by pressing it down with upper part of the frame mounted on hinges.

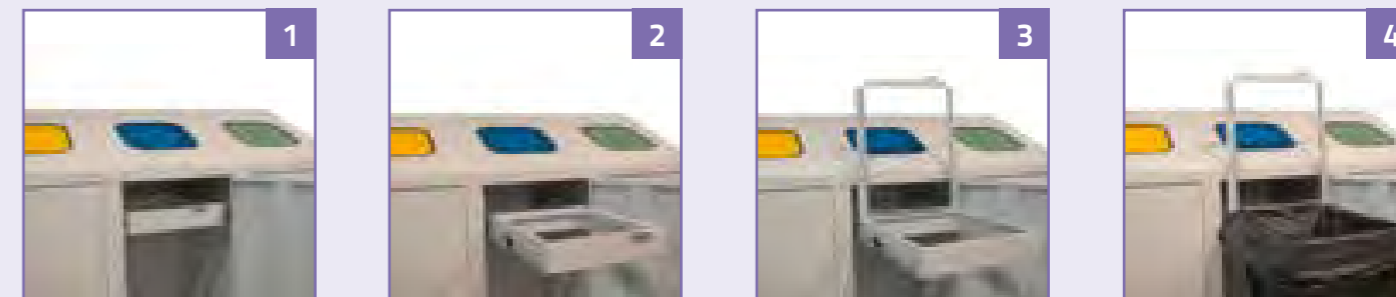

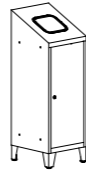
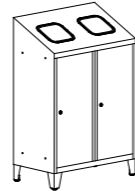
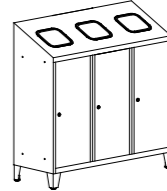
MPO metal recycling bin										
	Designation	MPO 01r	MPO 01k	MPO 02r	MPO 02k	MPO 02rk	MPO 03r	MPO 03k	MPO 03rrk	MPO 03kkr
Code	PNO 0101010301	PNO 0101010201	PNO 0201010301	PNO 0201010201	PNO 0401020101	PNO 0301010301	PNO 0301010201	PNO 0301010601	PNO 0301010501	
Height (mm)	1220		1220							
Width (mm)	400		800			1200				
Depth (mm)	450		450							
Number of units	1		2			3				
Equipment	1 frame for disposal bags	1 bin	2 frames for disposal bags	2 bins	1 frame for disposal bags + 1 bin	3 frames for disposal bags	3 bins	2 frames for disposal bags + 1 bin	2 bins + 1 frame for disposal bags	

Galvanized bin		
	Designation	MPO k galvanized metal bin
Code	XPNO 01010101	
Height (mm)	700	
Width (mm)	295	
Depth (mm)	357	



# SOCIAL FURNITURE

## SPORT WARDROBE LOCKER

### SPORT WARDROBE LOCKER

The door locked with blocking in 1 or 3 points . Door equipped with a check.

Locker equipment :

- the right part – equipped with 3 fixed shelves,
- the left part - equipped with 1 lockable compartment and a bar.

At the bottom of the cabinet there is one compartment for shoes, together with extended basis. The door is equipped with a metal container for small items and a set of 3 hooks for towels and clothes.

All shelves are spaced every 200 mm.

### SPORT CABINET FOR TRAINERS

The cabinet has the possibility of easy configuration of the following equipment:

- hooks e.g. for jump ropes, hula hoops,
- shelves (for plastrons),
- frame drawer with dividers (for bow-shaped handles, javelins),
- the possibility of mounting on the drawer a compartment for stopwatches, whistles and other small items.

These elements mentioned above are our standard offer and are height adjustable. Perforated door, with the full opening, lockable in 2pt.



## TECHNICAL SPECIFICATION

		
Designation	Sum 410 sport	Sbm 212 for sports equipment
Code	SUM 0601020102B80	SNSS 11032037
Height (mm)	1800	1990
Width (mm)	400	1200
Depth (mm)	490	500
Number of units	1	1





# SOCIAL FURNITURE

## SPORT WARDROBE LOCKER

### CABINETS FOR KEEPING SKIS AND SKI EQUIPMENT

Cabinet for 2 sets of skis, ski boots and helmets. Wardrobe cabinet is designed for sports, holiday and ski resorts. It is equipped with a set of 6 hooks for shoes and helmets, the bottom is equipped with galvanized bath-shelf and an upper shelf designed to store goggles and ski gloves.

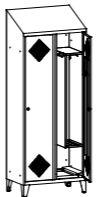

## TECHNICAL SPECIFICATION

Cabinets for skis	
Designation	Sum 421 for skis
Code	SUM 0701020201B81
Height (mm)	2140
Width (mm)	800
Depth (mm)	490
Number of units	2



# SOCIAL FURNITURE

## TABLES, BENCHES, CHAIRS AND HANGERS

A perfect addition to locker rooms and social rooms are the cloakroom benches, hangers, chairs and tables.



single benches - frame made of tubular steel



single benches - frame made from closed profile (Łsz 3, Łsz 3a)



single benches with solid wood – folding frame (BS)



one-side benches with support and hooks (Łsz 1, Łsz 1a)



double-side benches with support and hooks (Łsz 2, Łsz 2a)

## TECHNICAL SPECIFICATION

Tables, benches, chairs and hangers						
	Łsz 3	Łsz 3a	Łsz 1	Łsz 1a	Łsz 2	Łsz 2a
	LSZ 050205	LSZ 060205	LSZ 010101	LSZ 020101	LSZ 030102	LSZ 040102
	405		1650			
	1000	1500	1000	1500	1000	1500
	355		380		730	



Tables, benches, chairs and hangers							
	KD	ŁO 12	ŁO 16	ŁO 20	Bench BS	Table BS	WPPS 1
	KKD	LO 01010101	LO 02010101	LO 03010201	ŁAWKA BS	STÓŁ BS	PPSW 010101
	780/450	460	460		480	780	1845
	460	1200	1600	2000	2200	2200	600
	500	440	440		250	600	600
chair	garden bench	garden bench		garden bench	garden table	hanger	

# SOCIAL FURNITURE

## FURNITURE FOR SPECIAL ORDERS

In response to market demand we make furniture to order as well.

A modern machinery and experienced technical staff allow us to make even the most complicated orders.



## CUSTOMIZED PRODUCTS



HPL furniture



plexi doors



curved doors

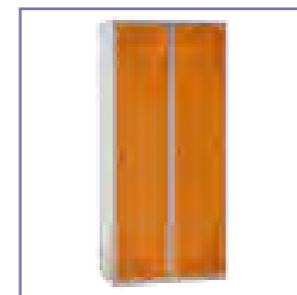

different perforations

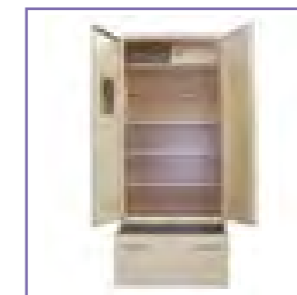

cabinets for army



individual projects

# MEDICAL FURNITURE

*Furniture  
you can depend on*



# MEDICAL FURNITURE

## CONTENTS

Sml Cabinets for Doctors	146
Szk Filing Cabinets	150
Doctor's Office	154
Szl Medical cabinets	158
Stl Surgery Tables	160
Bedside cabinets	162
Stainless Steel Furniture	164

There is medical furniture among our wide assortment of metal furniture as well. Here one can find doctor's cabinets, hanging cabinets, surgical tables, tables for dressing materials, bedside cabinets.

The furniture we offer makes perfect, high quality equipment for modern doctor's offices, laboratory rooms, scientific research facilities, hospitals, drug stores and other medical rooms.

We also manufacture the furniture made of acid-proof steel.

The possibility of installing wheels on tables and cabinets guarantees the appropriate functional features. The furniture is coated with high chemical resistant powder – in colours according to RAL palette.

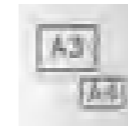

Sizes



Drawers on full extension ball bearing slides



Anti-tilt system



Central lock



Height adjustable feet



Possibility of hanging clothes



Elements for levelling

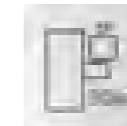

Maximum load capacity of drawers 50 kg



On wheels



Adjustable shelves



5 Kg shelf load capacity



25 Kg shelf load capacity



# MEDICAL FURNITURE

## SML CABINETS FOR DOCTORS

Cabinets for doctors are ideal for equipping doctor's offices, pharmacies, and other medical rooms. Cabinet doors are made of tempered glass. Glass shelves are adjustable every 25 mm. The door handle is equipped with a protecting lock which secures the doors in two points.



### STANDARD EQUIPMENT



doors with tempered glass

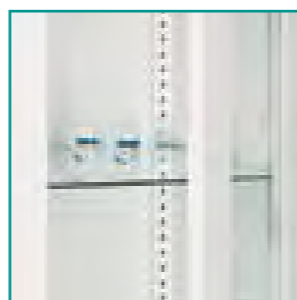

glass shelves – movable every 25 mm

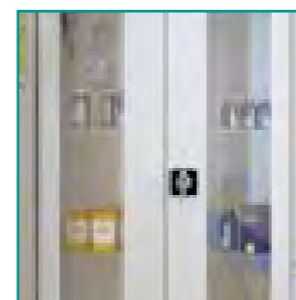

doors locked in 2 points

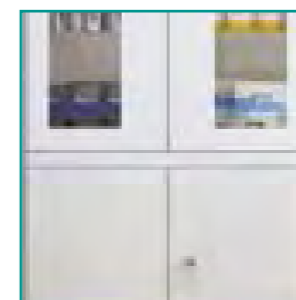

available cabinet with lockable lower compartment



versions of the cabinets on wheels









antistatic wheels, swivel, two with brakes, not leaving scuff marks on the floor



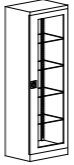



# MEDICAL FURNITURE

## SML CABINETS FOR DOCTORS

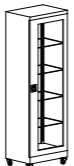
The cabinets are available in stainless steel sheet version, at an extra cost. It is possible to order the cabinet on wheels which allow for easy movement. Swivel wheels are antistatic, do not leave scuff marks on the floor, and two are with brakes.

							
Designation	Sml 101	Sml 112		Sml 103	Sml 114	Sml 115	Base
Code	SML 0101020101	SML 0201030101		SML 0301030101	SML 0201050401	SML 0201030701	PSUM 31060101
Height (mm)	1800			1800			140
Width (mm)	600	800		1000	800		600
Depth (mm)	435			435			434
Equipment	- 4 glass shelves			- 4 glass shelves	- In the lower part of the closed compartment with a glass shelf - In the upper part of the glass shelves	- 4 glass shelves - The sides of the cabinet made of glass	- base consisting of square tube legs - makes cabinets higher by 140 mm - legs equipped with adjustable feet

						
Designation	Sml 111	Sml 102		Sml 113	Sml 104	Sml 105
Code	SML 0101020102	SML 0201030102		SML 0301030102	SML 0201050402	SML 0201030702
Height (mm)	1890			1890		
Width (mm)	600	800		1000	800	
Depth (mm)	435			435		
Equipment	- wheels - 4 glass shelves			- wheels - 4 glass shelves	- wheels - in the bottom closing compartment - in the upper part glass shelves	- 4 glass shelves



# MEDICAL FURNITURE

## FILING CABINETS

In medicine, filing cabinets for A5, B6, A6 sizes are used mostly for patient cards. Drawers are mounted on double extension ball bearing slides and protected against falling out. There are self adhesive nameplates for drawer content labelling on the front of the drawer.



### ADVANTAGES OF CABINETS

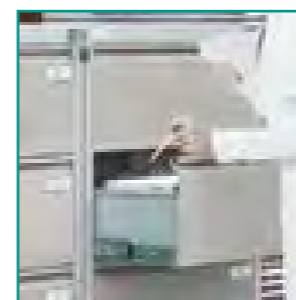

sizes most often used in medicine

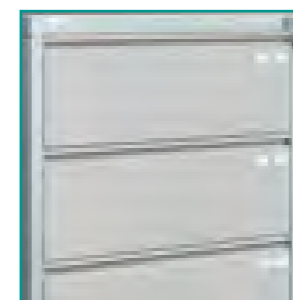

drawers central locking



self adhesive nameplate for each drawer



double extension ball bearing slides protected against falling out



# MEDICAL FURNITURE

## FILING CABINETS

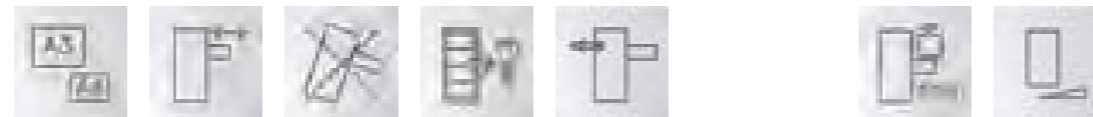
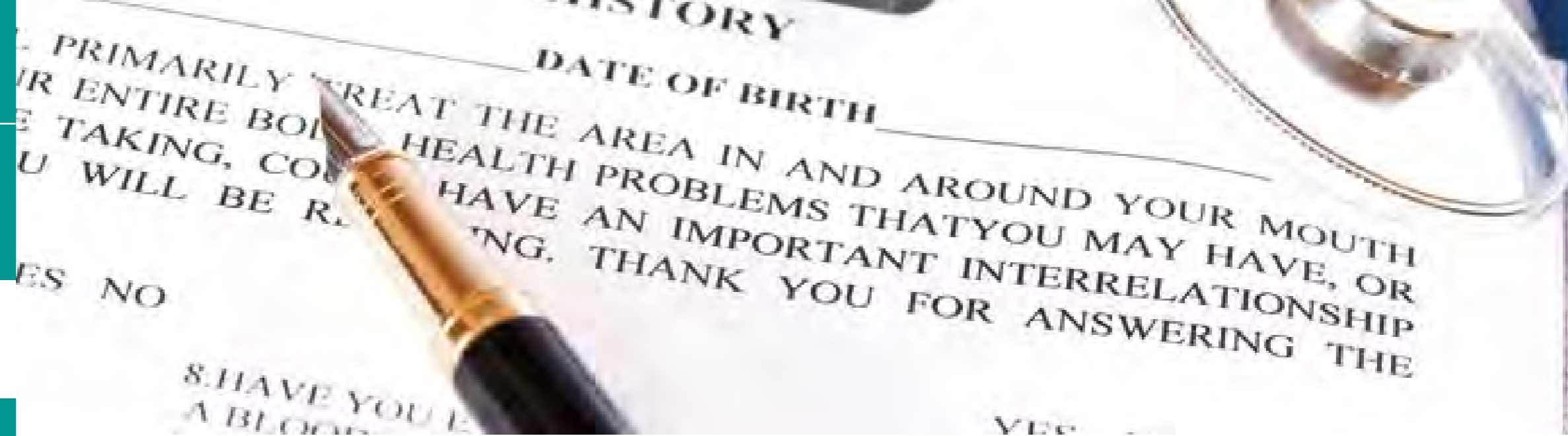
In medicine filing cabinets for A5, B6, A6 sizes are used mostly for patient cards. Drawers are mounted on double extension ball bearing slides and protected against falling out. There are the self adhesive nameplates for drawer content labelling on the front of the drawer.

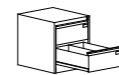
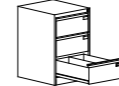
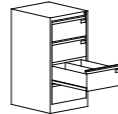
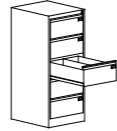
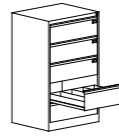

### TECHNICAL SPECIFICATION

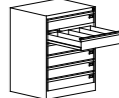
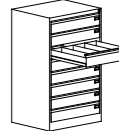
								
Designation	Szk 304/2	Szk 304/3	Szk 304/4	Szk 304	Szk 305	Szk 103	Szk 203	Szk 303
Code	SZK 03063401	SZK 03073501	SZK 03083601	SZK 03031101	SZK 02031301	SZK 02011401	SZK 02021501	SZK 02031601
Height (mm)	605	830	1060	1285	1285	715	1000	1285
Width (mm)	545		545		775	775		
Depth (mm)	630		630		630	630		
Number of drawers	2	3	4	5	5	4	6	8
Number of rows in the drawer	2		2		4	4		
Internal dimensions of drawers	H x W x D 187 (front 223) x 460 x 585		H x W x D 187 (front 223) x 460 x 585		H x W x D 100 (front 223) x 690 x 585	H x W x D 100 (front 137) x 690 x 585		
Sizes	A5 horizontally		A5 horizontally		A5 vertically	A6		

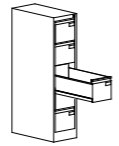
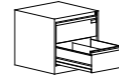
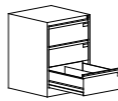
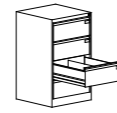
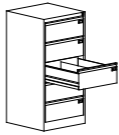
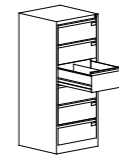
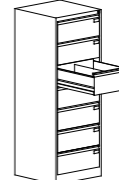
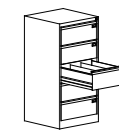
								
Designation	Szk 318/1/5	Szk 318/2	Szk 318/3	Szk 318/4	Szk 318	Szk 318/6	Szk 318/7	Szk 319
Code	SZK 11035002	SZK 09064502	SZK 09074602	SZK 09084702	SZK 09032102	SZK 09134802	SZK 09154902	SZK 09032202
Height (mm)	1285	605	830	1060	1285	1510	1740	1285
Width (mm)	345	610	610		610			610
Depth (mm)	630		630		630			630
Number of drawers	5	2	3	4	5	6	7	5
Number of rows in the drawer	1	2	2		2			3
Internal dimensions of drawers	H x W x D 150 (front 223) x 262 x 585		H x W x D 150 (front 223) x 262 x 585		H x W x D 150 (front 223) x 262 x 585			H x W x D 150 (front 223) x 522 x 585
Sizes	B5 horizontally		B5 horizontally		B5 horizontally			215 x 170 mm

# MEDICAL FURNITURE

## DOCTOR'S OFFICE

Our medical cabinets allow for a complex arrangement of every room. The presented visualizations are just suggestions. The choice is yours.



### EQUIPPING SUGGESTIONS



small, practical desks

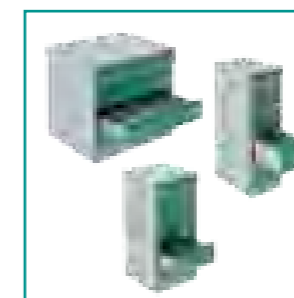

a wide selection of filing cabinets



additional equipment

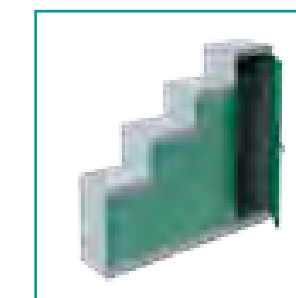

wide range of cabinets



# MEDICAL FURNITURE

## DOCTOR'S OFFICE





We suggest two kinds of desks designed for a doctor's office:

- small, highly functional STB desks with mobile pedestals,
- Zbm 304 desks with rounded top and with Szp mobile pedestal.

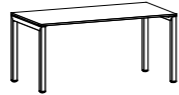
The 'Alicja' furniture set is highly functional as well. The set consists of Zbm desk and Zbm lockers (including one for clothes).

As an addition to medical furniture we offer an exam table, a stool, and a curtain – indispensable in a doctor's office.

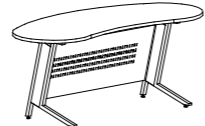

Desks		
Designation	Stb 1060	Stb 1080
Code	MST 0101010101	MST 0601010101
Height (mm)	745÷770	
Width (mm)	1000	
Depth (mm)	600	800

Mobile pedestals				
Designation	Szp 520	Szp 530	Szp 630	Szp 640
Code	MSZP 0101010101	MSZP 0101020101	MSZP 0102030101	MSZP 0102040101
Height (mm)	517		662	
Width (mm)	417			
Depth (mm)	556			
Equipment	- 1 higher drawer - 1 small drawer	- 3 small drawers	- 1 high drawer - 2 small drawers	- 4 small drawers

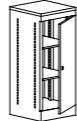
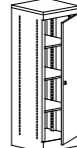
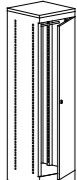
Alicja Furniture set	
Designation	Zbm 304
Code	STBJ 16020705
Height (mm)	740
Width (mm)	1800
Depth (mm)	800
Equipment	-melamine-covered top

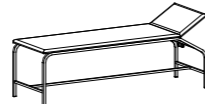
			
Zbm 102	Zbm 104	Zbm 106	Zbm 112
SZB 0101020302	SZB 0102020402	SZB 0103020502	SZB 0104020802
745	1030	1315	1600
		435	
		440	
- 1 adjustable shelf - melamine covered top	- 2 adjustable shelves - melamine covered top	- 3 adjustable shelves - melamine top	- shelf with a bar for hanging clothes - melamine covered top

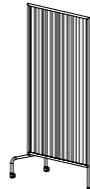
Additional equipment	
Designation	Exam table
Code	KOZETKA
Height (mm)	520
Width (mm)	560
Depth (mm)	1880
Description	- adjustable angle of abutment

		
Curtain	Curtain	Stool
PARAWANS	PARAWAN	TABORET
1850	1820	410-540
1000	1000	diagonal of the seat 350 mm
		diagonal of the seat 600 mm
- n 2 wheels	- on 2 wheels	- 350 mm diameter upholstered top - height adjustable - on wheels

# MEDICAL FURNITURE

## SZL MEDICAL CABINETS

The hanging cupboards make functional equipment for medical facilities or laboratory sites. Szl medical cabinets allow for arranging working space so as to maximize efficiency. They are equipped with sliding glass doors or metal winged doors – with a handle or magnetic lock. The cabinet with metal doors can serve as a first aid kit.

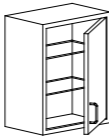
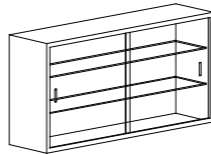

### TECHNICAL SPECIFICATION

Medical cabinets			
		Szl 102	Szl 103
Designation	Szl 101	Szl 102	Szl 103
Code	SZL 01010201	SZL 02010401	SZL 03010401
Height (mm)	500	500	
Width (mm)	400	800	1000
Depth (mm)	250	250	
Description	- hanging cabinet with one door having a handle and magnetic - two glass shelves inside	-hanging cabinet with sliding doors - glass doors and shelves	- hanging cabinet with sliding doors - glass doors and shelves

# MEDICAL FURNITURE

## STL SURGICAL TABLES

Surgical tables make it easy to transport tools in an operating block and for instrumenting.

Wheels enable moving the table and putting it in every place of a doctor's office or an operating theatre. All wheels are anti-static, not leaving scuff marks on the floor, swivel, and two of them are with the safety brakes. Maximal load capacity of the table is 50 kg.

Stl 201 surgical instrument table. Acceptable maximum load capacity - 10 kg. Raised and lowered by hand (within the scope of 920 - 1380 mm), dimensions of working top: 600 x of 400 mm. Adjusting top.



### TECHNICAL SPECIFICATION

Surgical table				
Designation	Stl 101	Stl 103	Stl 102	Stl 104
Code	STL 01010201	STL 02010201	STL 01010401	STL 02010401
Height (mm)	880		880	920-1380
Width (mm)	1000	1400	1000	400
Depth (mm)	600		600	600
Description	- surgical table			- surgical instrument table

# MEDICAL FURNITURE

## BEDSIDE CABINETS

Bedside cabinets are the essential equipment of hospital rooms, since they guarantee keeping the area around the patient's bed clean and orderly.

**Szp 1 cabinet** – the simplest and cheapest version of a bedside cabinet.

**Szl 201 bedside cabinet** – The cabinet with simple rotating and lifting mechanism. Symmetrical – the cabinet and its drawers open at both sides.

**Szl 201o bedside cabinet** – professional cabinet with lifting mechanism. There is also a possibility of adjusting the angle of the top.



### TECHNICAL SPECIFICATION



Szp 1



Szl 201

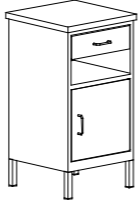
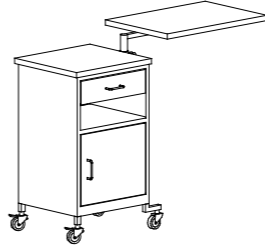
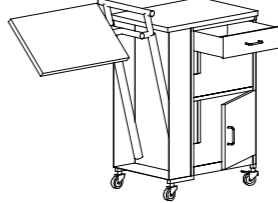

Szl 201o

Bedside cabinets			
Designation	Szp 1	Szl 201	Szl 201o
Code	SZL 0604020601	SZL 0402050402	SZL 0503050502
Height (mm)	800	800	945
Width (mm)	420	610	585
Depth (mm)	420	420	415
Description	Equipped with: - roll bearing slides, - tabletop, - cabinet with a hold.	- a simple tabletop rotating and lifting mechanism	- a lifted tabletop

# MEDICAL FURNITURE

## ACID-PROOF FURNITURE

Acid-proof furniture ensure maintaining cleanness and sterility, long-term durability, aesthetics and high quality. Those are for professional applications.

**Surgical instrument table.** With manually adjusted tray within the range of 911 – 1370 mm, size of 600x400 mm. Rotating tray with the possibility of blocking in every position. Maximum load capacity is 10 kg.

**The emergency table** is intended for moving the sterile materials, baskets, tools, drugs and other equipment around an operation block, hospital departments, emergency rooms and laboratories.



**Cabinet for anaesthetics** is equipped with a stand for liquids. The stand is adjustable in the range of 1300 – 2100 mm.

**Stand for liquids** – five-arm base, the upper part equipped with 4 hooks made of stainless rods. The stand is adjustable in the range of 1300 – 2200 mm.

**Operating platform** – steps are covered with anti-slide strips (made of material resistant to water, oil and UV radiation). Platform ensures the ergonomic working conditions during an operation.

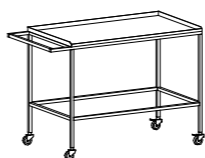
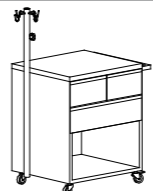

## TECHNICAL SPECIFICATION

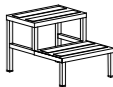
					
	Std	Stlk	Szla	Wmk	Two-step operating platform
Designation	Std	Stlk	Szla	Wmk	Two-step operating platform
Code	STLN 03020602	STLN 02010204	SZLN 0907011102	SJLN 01010101	SLN 010101
Height (mm)	911-1370	880	840	1360-2340	430
Width (mm)	460	1400	770	575	500
Depth (mm)	630	600	600	575	650



# WORKSHOP FURNITURE

*Furniture  
you can depend on*



# WORKSHOP FURNITURE

## CONTENTS

STW Workshop tables	170
TECHNO Workbenches	172
SZW Workshop boxes	174
SZW Workshop cabinets with drawers	176
SWM Workshop cabinets	178
RMM Storage racks	180
Industrial computer cabinets	182

During the design and manufacturing process, we care about all the details: order, safety, versatility, functionality, ergonomics, design and most importantly - people and their needs at the workstation. Our workshop cabinets, trolleys, boxes, workbenches, tool walls and industrial computer cabinets due to their high quality, functionality and durability will surely meet your expectations.

Our workshop furniture allow for practical arrangement of every workstation. Every workshop furniture is made of powder coated steel sheet protected from corrosion, in 16 standard colours.

It is also possible to customize the construction and the colour according to the client's individual needs.



For self-assembly



Various types of locks



Regulated levelling feet



Loading capacity of evenly loaded table – 450 kg



On wheels



Loading capacity of evenly loaded table – 600 kg



Load capacity of shelf – 15 kg



Loading capacity of evenly loaded table – 900 kg



Load capacity of shelf – 20 kg



Loading capacity of evenly loaded table – 1350 kg



Load capacity of shelf – 50 kg



Product with electrical components - safe



Load capacity of shelf – 75 kg

# WORKSHOP FURNITURE

## STW WORKSHOP TABLES

Our STW workshop tables combine high quality, strength and functionality.

STW Workshop tables are designed for mechanical workshops, tool departments, as well as small mechanical workshop and individual clients.

Workshop tables in combinations with metal cabinets, tool walls and storage racks provides great work organization according to the quotation: „Work smarter, not harder“.

Their diversity guarantees that they are perfectly fitted to the customer's individual needs.



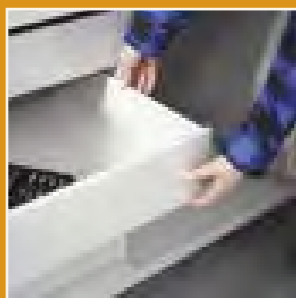

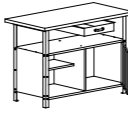
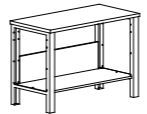
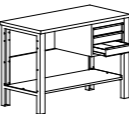
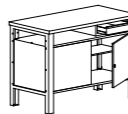
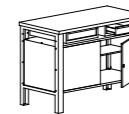
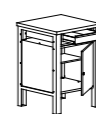

Tabletops are made from hardwood plywood. Tables are delivered in elements allowing for an easy assembly.

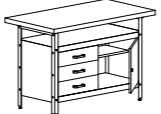

### TECHNICAL SPECIFICATION

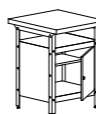
Workshop tables							
Designation	Stw 111	Stw 121	Stw 321	Stw 322	Stw 323	Stw 324	Stw 311
Code	STWS 01010201	STWS 02010202	STWS 02010103	STWS 02010104	STWS 02010305	STWS 02010306	STWS 01010207
Height (mm)	850		850				
Width (mm)	600	1200	1200	1200	1200	1200	600
Depth (mm)	600		600				
Dimensions of tabletop in mm (h x w x d)	30 x 600 x 600	30 x 1200 x 600	30 x 1200 x 600	30 x 1200 x 600	30 x 1200 x 600	30 x 1200 x 600	30 x 600 x 600

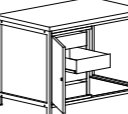
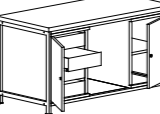
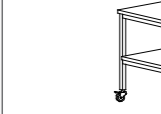
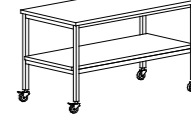

Workshop tables									
Designation	Stw 122	Stw 112	Stw 113	Stw 114	Stw 401	Stw 402	Stw 403	StbG 45	StbG 47
Code	STWS 02020211	STWS 01020207	STWS 01020212	STWS 01020113	STWS 04010209	STWS 05010310	STWS 06010310	GST 02020202	GST 01010201
Height (mm)	750		850					725 - 920	900
Width (mm)	1200	600	600	600	1200	1600	200	1200	1000
Depth (mm)	600		600		750		600		
Dimensions of tabletop in mm (h x w x d)	30 x 1200 x 600	30 x 600 x 600	30 x 600 x 600	30 x 600 x 600	40 x 1200 x 750	40 x 1600 x 750	40 x 2000 x 750		

# WORKSHOP FURNITURE

## TECHNO WORKBENCHES

By combining a modern design, an attractive painting and durable construction we have created reliable workbenches, satisfying even the most demanding users.

Due to the modular construction and two lines, Techno Workbenches offer the possibility to create a workbench in hundreds of combinations according to your needs:

- Techno Expert Workbenches - designed for professional applications,
- Techno Light Workbenches. - designed for professional as well as amateur applications.

Tables are delivered in elements allowing for an easy assembly.

Ask for the detailed catalogue of Techno Workbenches.





# WORKSHOP FURNITURE

## SZW WORKSHOP BOXES

Due to easy access to the tools, workshop boxes allow to keep the workstation orderly.

Perforated internal walls allow for easy hanging holders, brackets and hooks for tools.

Szw 104 and Szw 108 workshop boxes are equipped with drawers and shelves on roll bearing slides and a work desk on the top of the box.

Workshop boxes (except Szw 104 and Szw 108) are delivered in elements.



### TECHNICAL SPECIFICATION

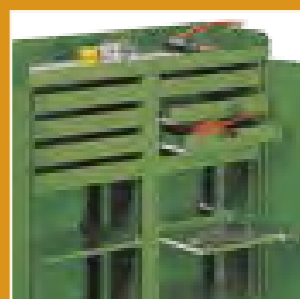
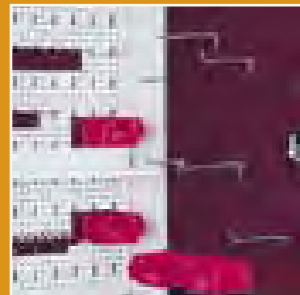

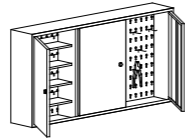
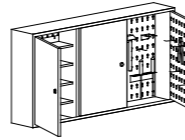
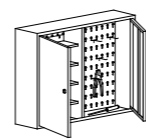
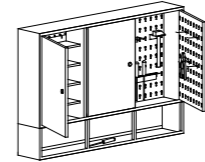
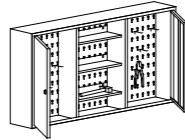
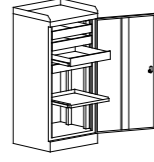
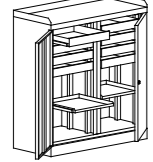
Workshop boxes							
Designation	Szw 120	Szw 121	Szw 080	Szw 122	Szw 123	Szw 104	Szw 108
Code	SZWS 02010201	SZWS 02010302	SZWS 01010103	SZWS 02020304	SZWS 02010205	SZW 0101010101	SZW 0201020201
Height (mm)	600	600	600	750	600	1090	928
Width (mm)	1200	1200	800	1200	1200	500	961
Depth (mm)	2000	200	200	200	200	435	600
Equipment	- 8 galvanized hooks - 145, 120, 85 mm each - 4 shelves	- 9 holders - wrench holder (1), drill holder (1), screwdriver holder (1), handle with single cut (1), holder with double cut (2), holder with oval cut (2) - 2 hooks - 85, 120, 145 mm each - backside of the doors have perforation	- 8 galvanized hooks - 145, 120, 85 mm each, 6 hooks of 120 mm long - 4 shelves	- 6 holders from 0.8 mm steel sheet, three holders from 1.5 mm steel sheet-wrench holder (1), drill holder (1), screwdriver holder (1), chisel holder (1), file holder (1), screwdriver open holder (1), holder with single cut (1), holder with double cut (1), holder with oval cut (1); two galvanized hooks - 4 shelves	- 5 galvanized hooks - 145, 120, 85 mm each, 3 shelves - middle part of the box without doors	- 4 drawers and shelf mounted on roll bearing slides - the top serves as a stand with edges on three slides - extendable shelf	- 8 drawers and two shelves mounted on roll bearings slides - the top serves as a stand with edges on three sides - 2 extendable shelves



# WORKSHOP FURNITURE

## SZW WORKSHOP LOCKERS WITH DRAWERS

### ŚNN TOOL WALLS

It is essential to have the most necessary tools within reach. This can be ensured by our tool walls. Tool walls can be placed according to individual users requirement. The perforated walls make the tools easily accessible and keep the workstation orderly.

### SZWN WORKSHOP TROLLEY

The workshop trolleys are equipped with:

- tabletops made from hardwood plywood,
- all drawers locked with central lock,
- drawers on roll bearings slides (maximum load capacity of 50 kg per drawer),
- doors locked with cylindrical lock,
- swivel wheels.

### SZWG LOCKER

Workshop locker on swivel wheels (2 with brakes). The top part made of perforated steel sheet (back and side walls), the bottom part with a shelf and 2 drawers. Set of hooks - according to the client's needs (at an extra cost).

## SZW WORKSHOP LOCKERS WITH DRAWERS

Szw lockers provide stable construction, central lock, anti-tilt system (preventing from opening more than one drawer at a time). Maximum load capacity per drawer: 75 kg. At the client's request the table top can be made of: rubber, plywood in metal frame or acid-proof steel sheet.

Drawer partitions are also available, allowing for dividing the drawer into 5 rows. Every row is equipped with 2 galvanized partitions.

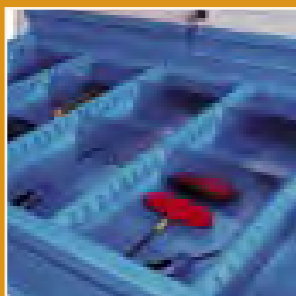

## TECHNICAL SPECIFICATION

Tool walls	
Designation	Śnn 300
Code	SNN 010101
Height (mm)	600
Width (mm)	1195
Depth (mm)	16
Equipment	-base board – 3 pcs, single hook (58 mm) -5 pcs, long slot holder for the screwdrivers – 1 pc, holder with circular holes – files – 1pc, holder with rectangular holes – chisels – 1 pc, holder for a drill – 1 pc, holder for the wrench – 1 pc, holder with circular holes for screwdrivers – 1 pc, holder for V container – 2 pcs, single holder – 4 pcs..



Szw 301

Workshop trolleys			
Designation	SzwN 251	SzwN 252	SzwG 43
Code	GWJ 0101020702	GWJ 0101010802	GWJ 03020306
Height (mm)	928		1930
Width (mm)	961		815
Depth (mm)	600		600
Equipment	5 drawers (including one deep drawer)	10 drawers (including 2 deep drawers)	- On wheels – the top part made of perforated steel sheet (back and side walls). The bottom part with a shelf and 2 drawers.

Workshop lockers with drawers			
Designation	Szw 301	Szw 302	Szw 305
Code	SZWL 0202010201	SZWL 0202010301	SZWL 0202010601
Height (mm)	1051	1051	1051
Width (mm)	1000	1000	1000
Depth (mm)	585	585	585
Height of drawers (mm)	width: 903 x depth: 435	width: 903 x depth: 436	width: 903 x depth: 437
Height of front	1 drawer 175 mm 2 drawers 225 mm 1 drawer 275 mm	1 drawer 75 mm 2 drawers 125 mm 2 drawers 175 mm 1 drawer 225 mm	7 drawers 75 mm 3 drawers 125 mm

# WORKSHOP FURNITURE

## SWM WORKSHOP CABINETS

### SWM WORKSHOP CABINETS

Anyone can choose the suitable cabinet for storing any kind of equipment in their workshop. Extremely strong and practical metal workshop cabinets perform well under any conditions. The height of shelves is adjustable due to mounting holes punched every 25 mm. Door handles are equipped with a 2 point blocking lock.

### SWM 501 WORKSHOP CABINET

Winged doors. Inside there is a perforated wall, 2 drawers, 2 shelves adjustable every 25 mm. Set of hooks – set individually (at an extra cost).

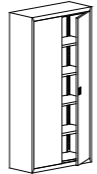
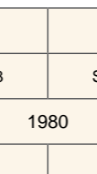
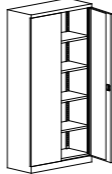
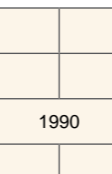
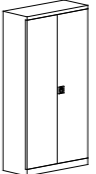
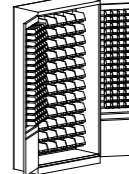
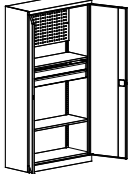

## TECHNICAL SPECIFICATION

Workshop Cabinets							
Designation	Swm 402	Swm 404	Sbm 203W	Sbm 212W	Swm 204	Swm 205	Swm 501
Code	SWMS 03020303	SWMS 04020303	SBM 03030304	SBM 04030304	SWM 0202030401	SWM 0202030402	SWML 01020204
Height (mm)	1980		1990		1990	1990	2000
Width (mm)	1000	1200	1000	1200	1000	1000	1020
Depth (mm)	420		435		435	435	435
Description	-self-assembly cabinets - 4 shelves		- 4 shelves adjustable every 25 mm		Workshop cabinet designed to be equipped with containers: - there are strips on the back wall of the cabinet, made for hanging 72 tool boxes (of dimensions as follows: 108x144x224/170mm) - there are metal strips on the doors of the cabinet for hanging 80 tool boxes (dimensions: 6x77x119/90mm) -containers are not included	Workshop cabinet with containers: - there are strips on the back wall of the cabinet, made for hanging 72 tool boxes (dimensions: 108x144x224/170mm) - there are metal strips on the doors of the cabinet made for hanging 80 tool boxes (dimensions: 6x77x119/90mm)	- perforated wall - 2 shelves - locker - 2 shelves



Swm 501

# WORKSHOP FURNITURE

## RMM STORAGE RACKS

Universal storage racks are essential everywhere where there are different objects stored, such as tools, cartons etc.

In order to shorten the time-consuming assembly of storage racks we designed racks assembled without screws. They are simple and easy to assemble and disassemble. Durability, solidity and quality are unique qualities of these storage racks. Elements of storage racks are made of powder coated metal sheets.





It is also possible to order storage racks made of galvanized acid-resistant steel.

In rack assembled with screws shelves are adjustable every 60 mm, and every 30 mm in racks assembled without screws.

Storage racks for self-assembly.

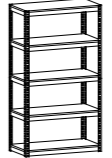

### TECHNICAL SPECIFICATION

Storage racks					
Designation	Rmm 302	Rmm 301	Rmm 303	Rmm 202	Rmm 201
Code	RMM 0301010201	RMM 0303040201	RMM 0305030201	RMM 0102020101	RMM0204030101
Height (mm)	900	1980	1800	1510	2000
Width (mm)	1000	1000		750	900
Depth (mm)	500	500		300	600
Number of shelves	3	6	5	4	5
Assembly with screws				+	+
Assembly without screws	+	+	+		
Load capacity (kg)	200	200		100	

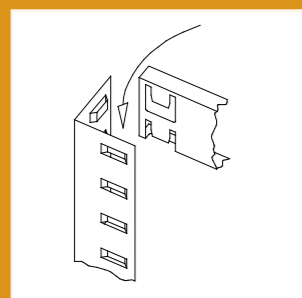

Assembly of snap-fit racks

# WORKSHOP FURNITURE

## CABINETS FOR INDUSTRIAL COMPUTER

Perfect solution for factories to store industrial computers.

### SPNK

The wardrobe has a flat structure of minimum depth. The front screen is adapted to assembly 16:9 LCD screen and of maximum 22 inches diagonal.

The resistance class, supported with examinations IP-42, ensure protection of the cabinet against foreign objects of over 1 mm size, and protection against drops of water falling down on the casing at the angle of 15 degrees.

The unscrewed base of the cabinet enables screwing the cabinet directly to ground.

Rich equipment as standard: a fan, a power supply, a service wire, and a power strip with the antiinterference filter.

### SMK

The upper glass part for LCD screen allows to use the equipment even if there is dust on the factory floor.

The bottom covered part serves for the safe-keeping of the computer and other devices.

Extendable shelf allows for using the keyboard easily and comfortably. The cabinet has legs with the possibility of levelling what allows to put it on each kind of floor, even the uneven one.

The cabinet is equipped with the inner electric fan that cools the working computer. In the bottom part of the cabinet there is a powering anti-interference slat. The back side has ventilation holes in it.

The adjustable shelf makes it possible to set its height depending on the kind of computer kept in the cabinet.



SmKa



#### Computer protection

Protection against dust and water, accidental damage and unauthorized access – IP 42 resistance class.



#### Stability

The unscrewed base of the cabinet enables screwing the cabinet directly to ground.

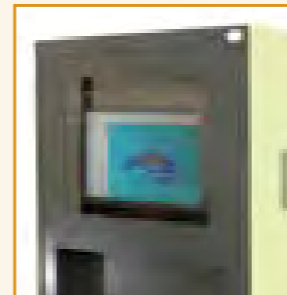

#### Functionality

The 4:3 front screen is adapted to assembly 16:9 LCD screen and of maximum 22 inches diagonal.

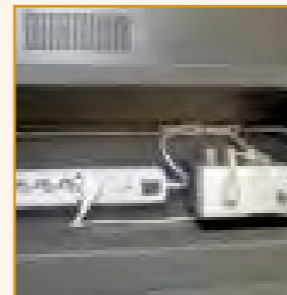

#### Wide range of accessories

Standard equipment: 2 shelves on latches, 1 extendable shelf for a computer, a fan, a power strip with the anti-interference filter, Ethernet loop, power strip, a handle for LCD screen, doors with a lock with patent filler – 3 point locking, Place for a keyboard closed with a cylindrical lock – locking in 1 point.

## TECHNICAL SPECIFICATION

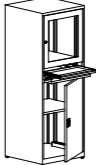
Industrial computer cabinet					
		SmK	SmKa	SmK1	SmK1a
Designation	SPNK	SMK 0101010201	SMK 0101010202	SMK 0101010101	SMK 0101010102
Code	SMK0506050506				
Height (mm)	1770	1750			
Width (mm)	755	640			
Depth (mm)	330	630			
Equipment	Cabinet equipped with: - a fan, - a power strip, - a terminal, - a power strip with the anti-interference filter.	The keyboard protecting part opens together with the main door. The cabinet with equipment: a fan and a power strip.	The keyboard protecting part opens separately. The cabinet with equipment: a fan and a power strip.	The keyboard protecting part opens together with the main door. The cabinet without any additional equipment.	The keyboard protecting part opens separately. The cabinet without any additional equipment.



# WORKSHOP FURNITURE

## INDUSTRIAL COMPUTER CABINET

### SMK 3A

Cabinets are equipped with the drawer for a keyboard and extendable shelf in the bottom compartment. On the side walls the cabinet has a ventilation. In the back wall of the cabinet there are holes for the power supply. Glass screen made of the tempered glass. The cabinet equipped with levelling feet.

### SMK 4A

Industrial computer cabinet – the glass part is adapted for the depth of the LCD screen. Extendable shelf allows for using the keyboard easily and comfortably. The back side has ventilation holes in it. The adjustable shelf makes it possible to set its height depending on the kind of computer kept in the cabinet.

### SMK 2

Industrial computer cabinet made of 0.8 mm thick steel sheet. There is one door at the entire height. A shelf for the LCD screen is fixed, other shelves can be adjusted every 25 mm. The cabinet can store LCD screen of size up to 17 inches.

The cabinet is equipped with a fixed shelf for a keyboard and a mouse (assembly at customer's place), a fan, a power strip with 4 sockets.



### SMK 3A



### SMK 4A



### SMK 2

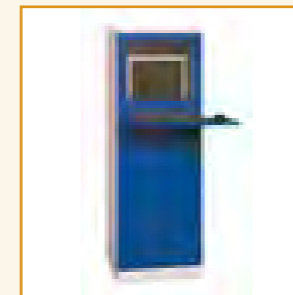

## TECHNICAL SPECIFICATION

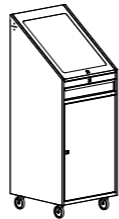
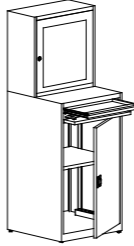
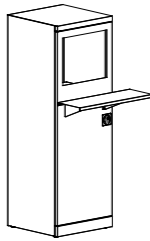
Industrial computer cabinet					
	SmK 3A	SmK 3A	SmK 4a	SmK 4a	SmK 2
Designation	SmK 3A	SmK 3A	SmK 4a	SmK 4a	SmK 2
Code	SMK 0405010104	SMK 0405010204	SMK 0101010105	SMK 0101010205	SMK 0202030203
Height (mm)	1545		1750		1600
Width (mm)	640		640		550
Depth (mm)	635		630		550
Equipment	Electric equipment not included. Equipped with: – keyboard shelf, – sliding shelf in the lower compartment, – ventilation on the sides, – holes for the wires at the back of the locker.	Electric with wiring system equipped with: – keyboard shelf, – sliding shelf in the lower compartment, – ventilation on the sides, – holes for the wires at the back of the locker.	- keyboard protecting part, - adjustable shelf, - fan, - power strip.	- keyboard protecting part, - adjustable shelf.	Cabinet equipped with: - fixed shelf for a keyboard and a mouse (assembly at customer's place), - fan, - power strip with 4 sockets.



# MOVEABLE SHELVING SYSTEM

*Furniture  
you can depend on*



## CONTENTS

LITREG crank driven movable shelving system

188

Movable shelving system with SOFT TOUCH electric drive

194

# MOVABLE SHELVING SYSTEM

## LITREG CRANK DRIVEN MOVABLE SHELVING RACKS

### WE UNDERSTAND THE NEEDS

We understand your needs for the equipment of offices, archives and libraries, thus we have movable shelving racks in offer. It is an ideal solution for the archiving and storing, as it gives unlimited possibilities and allows to use archival area at maximum.

### WE GUARANTEE THE FUNCTIONALITY

Wide range of the equipment possibilities ensure effective use of even the smallest space. Additional equipment: frame, extendable drawers, shelves and supports for documents ensure effective work.

### WE ENSURE THE SATISFACTION

We will present our offer on your every single enquiry. We will design the plan of developing an archive, a warehouse or an office with bookshelves at no extra cost, proposing the most advantageous solutions. Together we will create the optimal solution for the efficient use of rooms.



## VARIOUS SOLUTIONS



## SHELVING FOR A MEDAL

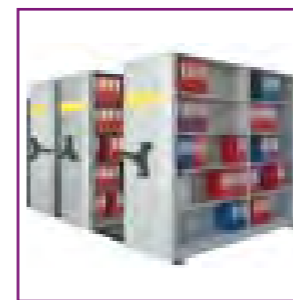

open shelving rack



shelving rack with  
sliding doors



shelving rack with  
winged doors



closing shelving rack

# MOVABLE SHELVING SYSTEM

## LITREG CRANK DRIVEN MOVABLE SHELVING SYSTEM

We offer solutions which adapt to people's needs and guarantee functionality, dynamics, efficiency of use and friendly atmosphere.

There is a possibility of adjusting the height of shelving racks and width of shelves according to customer needs.



Extendable frame drawer – an easy access to files.



Extendable shelf – ensures comfort of use.



Book support - for comfortable use and organized files.



Crank mechanism with blockade - safe manual.

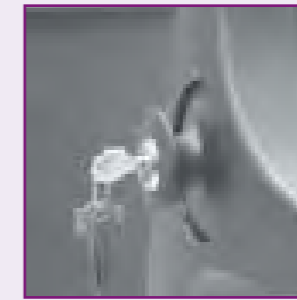

Crank mechanism with blockade with a lock - additional security.



Solid frame bearer guarantees stability and durability.

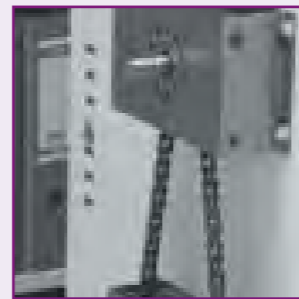

Solid crank mechanism - big transmission, easy to move.

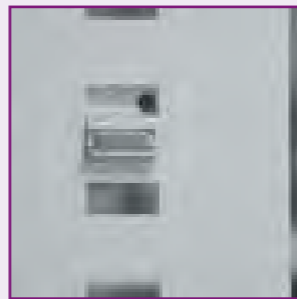

Adjustable shelves – guarantee flexibility of shelving racks.



Strengthening cross bar - ensures stability and stiffness of shelving rack's construction.

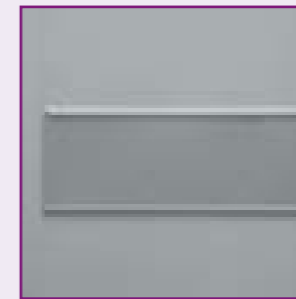

Frame with card holder - allows for proper organization of documents.

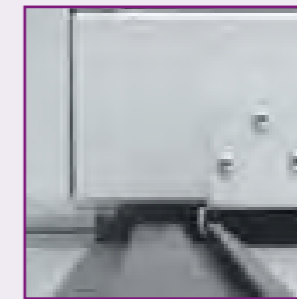

Embedded trackage.



Surface trackage.

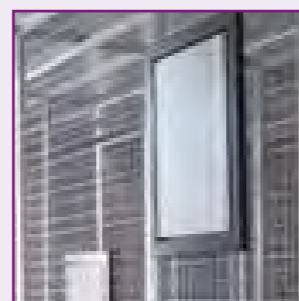

Mesh panel system - for safe paintings storage.

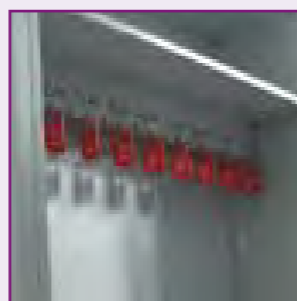

Wardrobe rack - wide range of use.

## TECHNICAL SPECIFICATION

Height (mm)	2019		2394	
Shelf's width (mm)	1000			
Shelf's depth (mm)	250	300	350	370
Shelves per unit	5 or 6 shelves + 1 top shelf as a cover			
Distance between shelves	350 mm			
Shelf's adjustment	every 25 mm			
Loading capacity	40 kg		80 kg – (option)	
Distance buffers	20 mm thick			
Drive	Crank driven			
Additional equipment	<ul style="list-style-type: none"> <li>- shelf's partitions</li> <li>- a lock – a blockade</li> <li>- full and frame drawers for hanging files (only for 370 mm deep shelf )</li> <li>- extendable shelves</li> <li>- mesh panel system--wardrobe rack</li> </ul>			

# MOVABLE SHELVING SYSTEM

## LITREG CRANK DRIVEN MOVABLE SHELVING SYSTEM



3D Model  
400 running metres of shelving

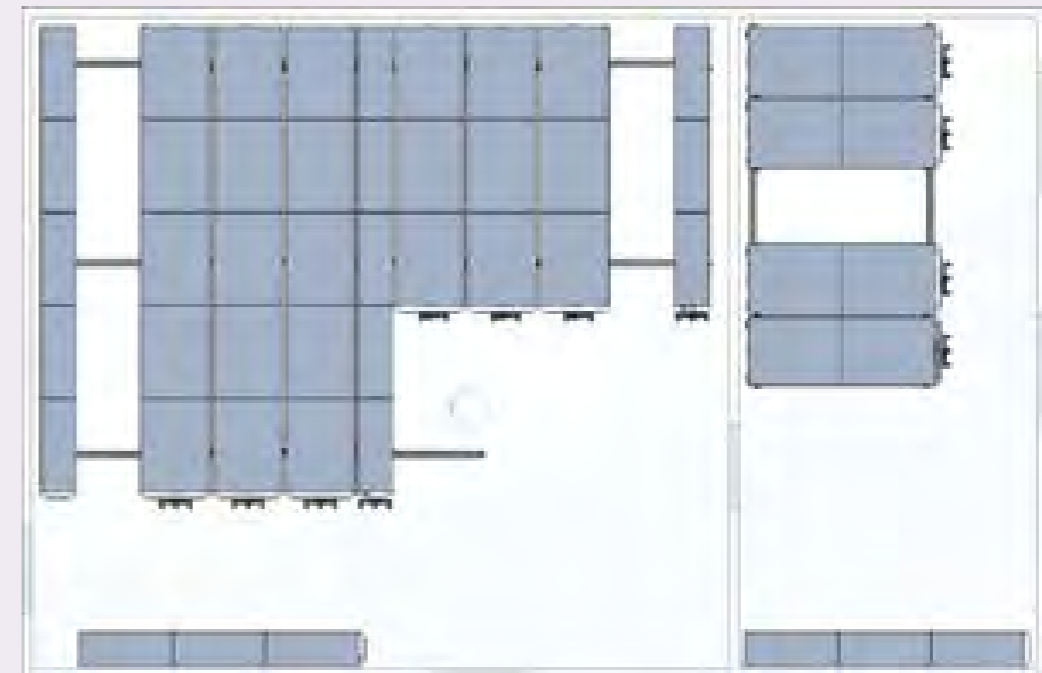

furnishing project  
400 running metres of shelving

### ECONOMY OF SPACE

Standard shelving rack allows to store only 1040 file boxes.

By applying LITREG CRANK DRIVEN MOVABLE SHELVING SYSTEM it is possible to double the storage place.

Furnishing the same area with our movable shelving racks allows to store 2080 file boxes.

Because of individual technical conditions and customer's requirements, we provide you with a project together with the estimated cost only after receiving the information about available space and the requirements.

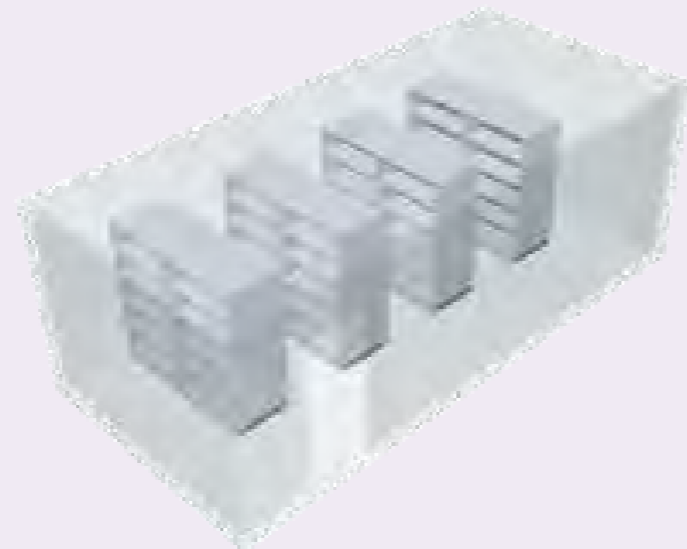

standard racks  
80 running metres - ca. 1040 file boxes



movable shelving racks  
160 running metres - ca. 2080 file boxes



# MOVABLE SHELVING SYSTEM

MOVABLE SHELVING SYSTEM  
WITH SOFT TOUCH  
ELECTRIC DRIVE

## MODERN SYSTEM

The movable shelving racks with SOFT TOUCH system is a truly innovative solution. Moving particular units no longer requires any physical effort. Tap gently in specific spot to access to required archives. This is a perfect solution for large and often used archives, when user is carrying documents and cannot use his hands, and especially for disabled people. Shelving rack moves smoothly, what protects files against changing their position during the action.



## VARIOUS SOLUTIONS



## SHELVING FOR A MEDAL



shelving rack with  
sliding doors



shelving rack  
with shelves



shelving rack  
with mesh panel



# MOVABLE SHELVING SYSTEM

## MOVABLE SHELVING SYSTEM WITH SOFT TOUCH ELECTRIC DRIVE



The trackage is galvanized. The total height of the track is 12 mm. Trackage is anchored to the floor with expansion bolts. The outermost tracks have an anti-tilt system, protecting against overturning. Optimally selected number of rails ensures smooth and easy movement of units. There is also a possibility of installing a chain in the trackway.

## SHELVING RACK'S FUNCTIONS

Movable shelving system provides the possibility of transmission by means of following elements: electric motor and cogwheels coupled with transmission shaft.

The control system has the following functions:

- opening,
- blocking,
- resetting,
- failure alarm,
- moving apart, airing,
- user protection, safety.



## FRAME CHASSIS

The frame is made of powder coated steel profiles coloured in RAL 7035. The frame is equipped with shafts and cast iron wheels. The wheels have ball bearing to improve the quality of use. The frames are equipped with rubber distance buffers in order to prevent units from sliding off. Movable shelving system provide the possibility of transmission by means of following elements: electric motor, cogwheels coupled with transmission shaft.

## LOAD-BEARING WALL



The load-bearing wall is made of powder coated steel sheet and perforated every 25 mm (either in intervals or continuously). Thus shelves can be adjusted at any desired height. For additional rigidity of units, a cross-wise strengthening is applied.

# MOVABLE SHELVING SYSTEM

## MOVABLE SHELVING SYSTEM WITH SOFT TOUCH ELECTRIC DRIVE

Movable shelving system with SOFT TOUCH electric drive links features of archiving huge stores of documentation with the greatest customer service.



Shelves are made of powder coated steel sheet and are equipped with a stop, which prevents documents from moving. Shelf's loading capacity is 40 kg or 80 kg (as an option). The front wall from the side of control panel, is covered with a decorative panel.



## SAFETY



The shelving is designed with a possibility of locking with special keys. The access to particular units might be restricted to employees who possess the key. The shelving also have in-built 'night positioning' option. All units slide in equal distance to each other so as to provide additional ventilation. Units are equipped with electric overload protection, that reacts to all obstacles while moving. Additionally, the shelving is equipped with a passive safety system. The system forces users to have a look at an opened alley, before it moves to another. All the functions guarantee safe use.

# MOVABLE SHELVING SYSTEM

## MOVABLE SHELVING SYSTEM WITH SOFT TOUCH ELECTRIC DRIVE

Movable shelving system with modern electric propulsion. The control panel and the entire mechanism of the electric drive are fine-tuned in every detail, with the greatest safety consciousness and comfort of the user.



The movement of the system is held through the control panel placed on the front wall of each unit. There is a possibility of moving all units with one control unit. Control panel indicates the direction of movement and opening of a corridor. Opening and closing of a particular unit comes down just to press the button on the control panel. This panel is equipped with the system of signal diodes, informing about the system failure. Additional control program is detecting and signaling the place and the kind of a breakdown.

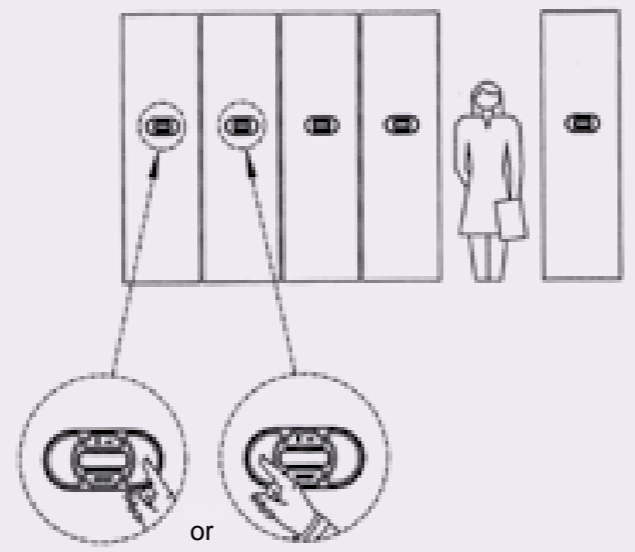

The units are moved through the control panel.



Cords are in cable channels put on the top of the unit- as shoulders between elements.

# MOVABLE SHELVING SYSTEM

## MOVABLE SHELVING SYSTEM WITH SOFT TOUCH ELECTRIC DRIVE

There is a possibility of adjusting the height and the gauge of shelves and of selecting solutions to individual needs of users.

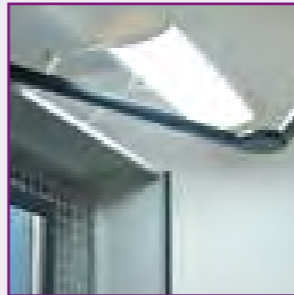

Lighting of the space between units. The illumination is controlled electronically and works only above the unit currently used by personnel. Lighting covers are placed on metal trusses, screwed to the top shelves (the covering). The illumination starts automatically when the alley is opening and switches off when it is closing, provided software allows user to set the time after which the light is switched off.

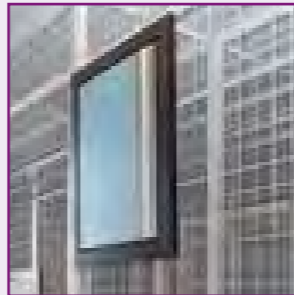

Mesh panel system for safe storage of images.

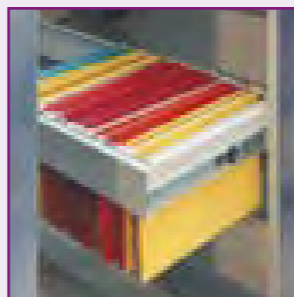

Pull-out frame drawers facilitating access to documents.

## SOFT TOUCH SYSTEM TECHNICAL SPECIFICATION



Height (mm)	2019	2394
Shelf's width (mm)	1000	750
	or set individually	
Shelf's depth (mm)	300	
Number of shelves	5 or 6 shelves + 1 covering shelf (dust cover)	
Distance between shelves	350 mm or set individually	
Shelf's adjustment	every 25 mm	
Shelf's load capacity	40 kg	80 kg (option)
Distance buffers	20 mm thick	
Drive	Electric	
Additional equipment	<ul style="list-style-type: none"> <li>- shelf's dividers</li> <li>- lightning</li> <li>- pull-out frame drawers</li> <li>- mesh panels</li> </ul>	









RAL 9010

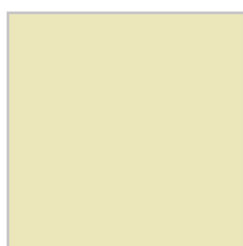

RAL 1015



RAL 7032



RAL 8016

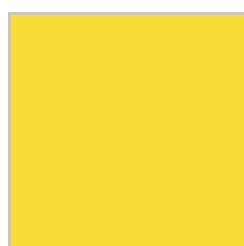

RAL 1023

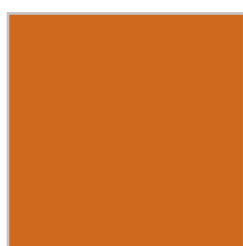

RAL 2004

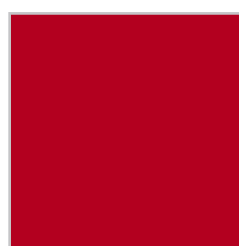

RAL 3020



RAL 3005



RAL 6011

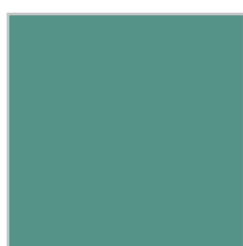

RAL 6033



RAL 5018



RAL 7016



RAL 5012



RAL 5010



RAL 7035

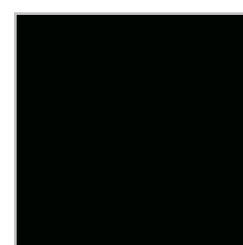

RAL 9005

The only purpose of this table is to show the colours roughly. For more accurate view please see full RAL colours palette. We reserve the right to possibility of occurring insignificant differences from the given colours, what should not be a reason of any complaints.

We also reserve the right to implement construction changes in our production, what can have insignificant influence on the product appearance.

Colours of products shown in the photographs in the catalogue and the visualisations have demonstrative character only and may differ from the colours of the offered products.

**MALOW Spółka z o.o.**

ul. Wojska Polskiego 114 A  
16-400 Suwałki  
POLAND  
[www.malow.pl](http://www.malow.pl)  
[marketing@malow.com.pl](mailto:marketing@malow.com.pl)  
tel. +48 87 566 07 44, 43, 40  
fax +48 87 566 07 27

