

1 2 3 4 5 6 7 8

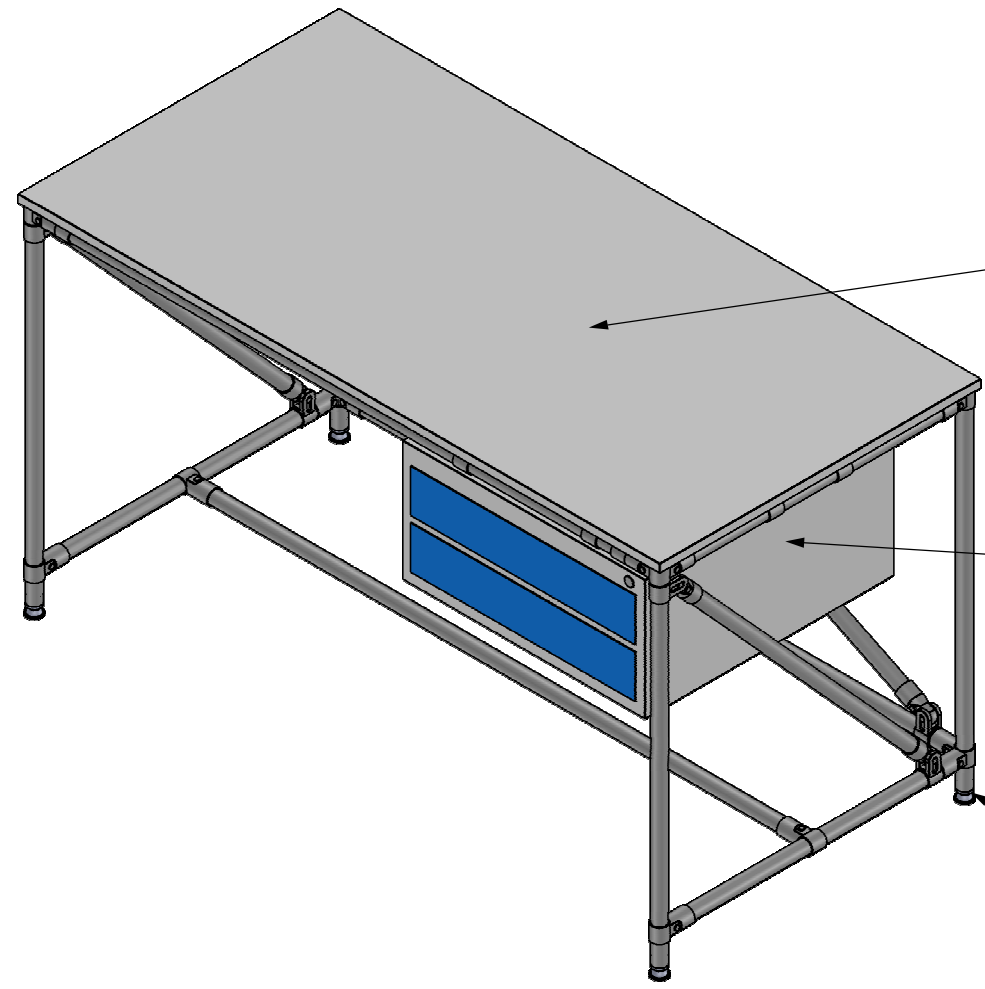
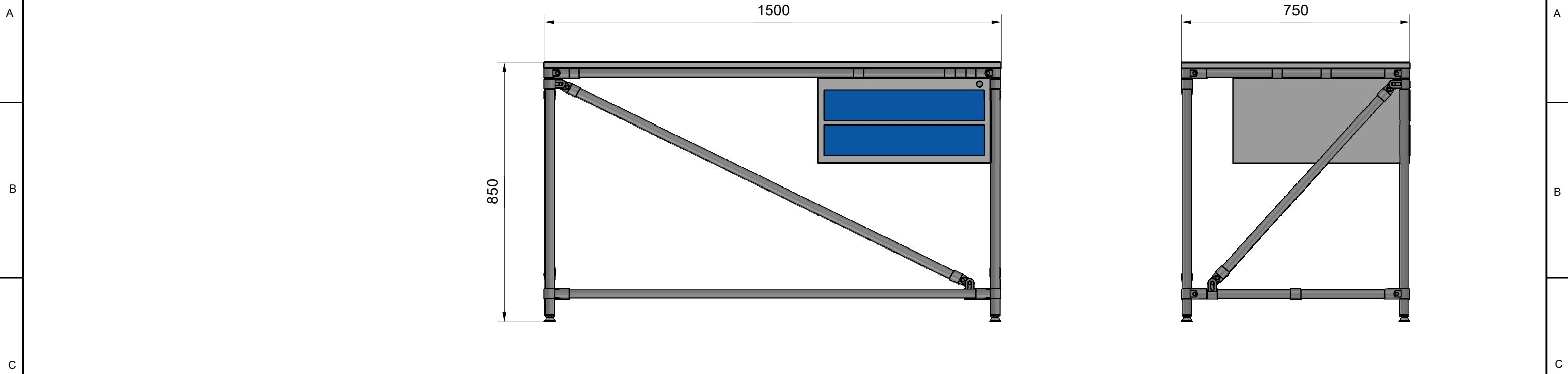

Dřevotřísková deska oboustranně laminovaná v dekoru 112 Kamenná šedá

Stolový kontejner XB20-2TG

4x stavitelné nožičky

Workshop accuracies for general tolerances - Tolerances for length and angle dimensions; DIN ISO 2768-1-v				
-Machining details and finish classification to DIN ISO 1302				
E	Total load capacity*: (Celková nosnost:*)	100 kg	Load capacity - floor*: (nosnost na patro:*)	
	Scale	A3	Drawn Kempný	Checked Dat. 08.04.2024
Enprag	Title			Sheet 1 of 1
	Title Dílenský stůl			Rev. A00
				Doc.Nr 24040538

This document is the sole property of Enprag s.r.o. and may not be copied, duplicated, used or given to third parties without the written permission from Enprag s.r.o. Misuse is subject to penalties and will be legally pursued

Tolerances for shape and condition:
- DIN ISO 2768-2-K
Tolerancing:
- DIN 7167

1 2 3 4 5 6 7 8